

FCC Compliance Statement:

| |
|---|
| <p style="text-align: center;">DECLARATION OF CONFORMITY <small>Per FCC Part 2, Section 2.107(a)</small></p> <p style="text-align: center;">FCC</p> <p>Responsible Party Name: G.B.T. INC. Address: 18385 Valley Blvd., Suite 614 LA Puente, CA 91744 Phone/Fax No: (818) 854-9338 / (818) 854-9339</p> <p>hereby declares that the product Product Name: Mother Board Model Number: GA-7VMM</p> <p>Conforms to the following specifications: FCC Part 15, Subpart B, Section 15.107(a) and Section 15.109(a), Class B Digital Device</p> <p>Supplementary Information: This device complies with part 15 of the FCC Rules. Operation is subject to the following two conditions: (1) This device may not cause harmful interference, and (2) this device must accept any interference received, including that which may cause undesired operation.</p> <p>Representative Person's Name: <u>ERIC LI</u> Signature: <u>Eric Li</u> Date: <u>May 08, 2001</u></p> |
|---|

This equipment has been tested and found to comply with limits for a Class B digital device, pursuant to Part 15 of the FCC rules. These limits are designed to provide reasonable protection against harmful interference in residential installations. This equipment generates, uses, and can radiate radio frequency energy, and if not installed and used in accordance with the instructions, may cause harmful interference to radio communications. However, there is no guarantee that interference will not occur in a particular installation. If this equipment does cause interference to radio or television equipment reception, which can be

determined by turning the equipment off and on, the user is encouraged to try to correct the interference by one or more of the following measures:

- Reorient or relocate the receiving antenna
- Move the equipment away from the receiver
- Plug the equipment into an outlet on a circuit different from that to which the receiver is connected
- Consult the dealer or an experienced radio/television technician for additional suggestions

You are cautioned that any change or modifications to the equipment not expressly approve by the party responsible for compliance could void Your authority to operate such equipment.

This device complies with Part 15 of the FCC Rules. Operation is subjected to the following two conditions 1) this device may not cause harmful interference and 2) this device must accept any interference received, including interference that may cause undesired operation.

Declaration of Conformity

We, Manufacturer/Importer
(full address)

G.B.T. Technology Trading GmbH
Ausschlager Weg 41, 1F, 20537 Hamburg, Germany

declare that the product
(description of the apparatus, system, installation to which it refers)

Mother Board
GA-7VMM

is in conformity with
(reference to the specification under which conformity is declared)
in accordance with 89/336 EEC-EMC Directive

- | | | | |
|---|--|--|--|
| <input type="checkbox"/> EN 55011 | Limits and methods of measurement of radio disturbance characteristics of industrial, scientific and medical (ISM high frequency equipment | <input type="checkbox"/> EN 61000-3-2* <input checked="" type="checkbox"/> EN60555-2 | Disturbances in supply systems caused by household appliances and similar electrical equipment "Harmonics" |
| <input type="checkbox"/> EN55013 | Limits and methods of measurement of radio disturbance characteristics of broadcast receivers and associated equipment | <input type="checkbox"/> EN61000-3-3* <input checked="" type="checkbox"/> EN60555-3 | Disturbances in supply systems caused by household appliances and similar electrical equipment "Voltage fluctuations" |
| <input type="checkbox"/> EN 55014 | Limits and methods of measurement of radio disturbance characteristics of household electrical appliances, portable tools and similar electrical apparatus | <input checked="" type="checkbox"/> EN 50081-1 <input checked="" type="checkbox"/> EN 50082-1 | Generic emission standard Part 1: Residual, commercial and light industry Generic immunity standard Part 1: Residual, commercial and light industry |
| <input type="checkbox"/> EN 55015 | Limits and methods of measurement of radio disturbance characteristics of fluorescent lamps and luminaries | <input type="checkbox"/> EN 55081-2 | Generic emission standard Part 2: Industrial environment |
| <input type="checkbox"/> EN 55020 | Immunity from radio interference of broadcast receivers and associated equipment | <input type="checkbox"/> EN 55082-2 | Generic immunity standard Part 2: Industrial environment |
| <input checked="" type="checkbox"/> EN 55022 | Limits and methods of measurement of radio disturbance characteristics of information technology equipment | <input type="checkbox"/> ENV 55104 | Immunity requirements for household appliances tools and similar apparatus |
| <input type="checkbox"/> DIN VDE 0855 <input type="checkbox"/> part 10 <input type="checkbox"/> part 12 | Cabled distribution systems; Equipment for receiving and/or distribution from sound and television signals | <input type="checkbox"/> EN 50091- 2 | EMC requirements for uninterruptible power systems (UPS) |

CE marking



(EC conformity marking)

The manufacturer also declares the conformity of above mentioned product with the actual required safety standards in accordance with LVD 73/23 EEC

- | | | | |
|-----------------------------------|---|-------------------------------------|---|
| <input type="checkbox"/> EN 60065 | Safety requirements for mains operated electronic and related apparatus for household and similar general use | <input type="checkbox"/> EN 60950 | Safety for information technology equipment including electrical business equipment |
| <input type="checkbox"/> EN 60335 | Safety of household and similar electrical appliances | <input type="checkbox"/> EN 50091-1 | General and Safety requirements for uninterruptible power systems (UPS) |

Manufacturer/Importer

Signature: Rex Lin

(Stamp)

Date : May, 08, 2001

Name : Rex Lin

7VMM

AMD Athlon™/Duron™ Socket A Processor
Motherboard

USER'S MANUAL

AMD Athlon™/Duron™ Socket A Processor Motherboard
REV 1.0 Second Edition
R-10-02-010806

How This Manual Is Organized

This manual is divided into the following sections:

| | |
|----------------------------------|---|
| 1) Revision List | Manual revision information |
| 2) Item Checklist | Product item list |
| 3) Features | Product information & specification |
| 4) Installation Guide | Instructions on CPU & Memory Installation |
| 5) Performance & Block Diagram | Product performance & block diagram |
| 6) Suspend to RAM | Instructions on STR installation |
| 7) BIOS Flash Utility | BIOS Flash utility introduction |
| 8) @BIOS™ & EasyTuneIII™ | @BIOS™ & EasyTuneIII™ introduction |
| 9) BIOS Setup | Instructions on setting up the BIOS software |
| 10) Technical Support /RMA Sheet | Document equipment used for after sales service |
| 11) Appendix | General reference |

Table Of Content

| | |
|---|------|
| Revision History | P.1 |
| Item Checklist | P.2 |
| Feature Summary | P.3 |
| 7VMM Motherboard Layout | P.5 |
| Installation Guide | P.6 |
| Page Index for Connectors / Panel and Jumper Definition | P.12 |
| Performance List | P.29 |
| Block Diagram | P.30 |
| Suspend to RAM Installation (Optional) | P.31 |
| BIOS Flash Utility Introduction | P.37 |
| @BIOS™ Introduction (Optional) | P.39 |
| EasyTuneIII™ Introduction (Optional) | P.40 |
| Page Index for BIOS Setup | P.42 |
| Technical Support /RMA Sheet | P.69 |
| Appendix | P.70 |

Revision History

| Revision | Revision Note | Date |
|----------|--|----------|
| 1.0 | Initial release of the 7VMM motherboard user's manual. | May.2001 |
| 1.0 | Second release of the 7VMM motherboard user's manual. | Aug.2001 |

The author assumes no responsibility for any errors or omissions that may appear in this document nor does the author make a commitment to update the information contained herein. Third-party brands and names are the property of their respective owners.

Aug.06, 2001 Taipei, Taiwan, R.O.C

Item Checklist

- The 7VMM Motherboard
- Cable for IDE / Floppy device
- Driver CD for motherboard utilities
- 7VMM User's Manual
- Internal COM B Cable (Optional)

Features Summary

| | |
|----------------------|--|
| Form Factor | <ul style="list-style-type: none"> • 20.6 cm x 24.3 cm Micro ATX size form factor, 4 layers PCB. |
| Motherboard | <ul style="list-style-type: none"> • 7VMM includes 7VMM , 7VMM-I |
| CPU | <ul style="list-style-type: none"> • AMD Athlon™/Duron™ (K7) Socket A Processor • 256K/64K L2 cache on die • Supports 600MHz ~ 1GHz and above |
| Chipset | 7VMM, consisting of: <ul style="list-style-type: none"> • VT8361 Memory/AGP/PCI Controller(PAC) • VT82C686B PCI Super-I/O Integrated Peripheral Controller (PSIPC) |
| Clock Generator | <ul style="list-style-type: none"> • ICS94236 100 / 133 MHz system bus speeds |
| Memory | <ul style="list-style-type: none"> • 2 168-pin DIMM sockets • Supports PC-100 / PC-133 SDRAM and VCM SDRAM • Supports up to 2.0GB DRAM • Supports only 3.3V SDRAM DIMM |
| I/O Control | <ul style="list-style-type: none"> • VT82C686B |
| Slots | <ul style="list-style-type: none"> • 3 PCI slots supports 33MHz & PCI 2.2 compliant • 1 AMR (Audio Modem Riser) slot • 1 ISA slot (Optional) |
| On-Board IDE | <ul style="list-style-type: none"> • IDE 1 and IDE 2 Supports PIO mode 3, 4, UDMA 33 / ATA 66 / ATA100 IDE & ATAPI CD-ROM • 2 IDE bus master IDE ports for up to 4 ATAPI devices |
| On-Board Peripherals | <ul style="list-style-type: none"> • 1 floppy port supports 2 FDD with 360K, 720K, 1.2M, 1.44M and 2.88M bytes • 1 parallel ports supports Normal/EPP/ECP mode • 2 serial ports (COM A , COM B is Optional Cable) • 4 USB ports (2 USB by optional cable) • 1 IrDA connector for IR |
| Hardware Monitor | <ul style="list-style-type: none"> • CPU/System fan revolution detect • CPU/System temperature detect • System voltage detect |

To be continued...

Features Summary

| | |
|---------------------|---|
| On-Board Sound | <ul style="list-style-type: none">• AC'97 CODEC• Line In / Line Out / Mic In / CD In / Game port• TEL / AUX In (Optional) |
| On-Board VGA | <ul style="list-style-type: none">• Build Trident Blade 3D Graphics Controller in VT8361• Support Shared memory architecture |
| PS/2 Connector | <ul style="list-style-type: none">• PS/2[®] Keyboard interface and PS/2[®] Mouse interface |
| BIOS | <ul style="list-style-type: none">• Licensed AMI BIOS, 2M bit flash ROM |
| Additional Features | <ul style="list-style-type: none">• Support Wake-On-LAN (WOL)• Support Internal / External Modem Ring On• Support USB KB/MS Wake up from S3• Includes 3 fan power connectors• Poly fuse for keyboard over-current protection• Support STR (Suspend-To-RAM) function (Optional)• Support @BIOS[™] and EasyTuneIII[™] |

7VMM Motherboard Layout

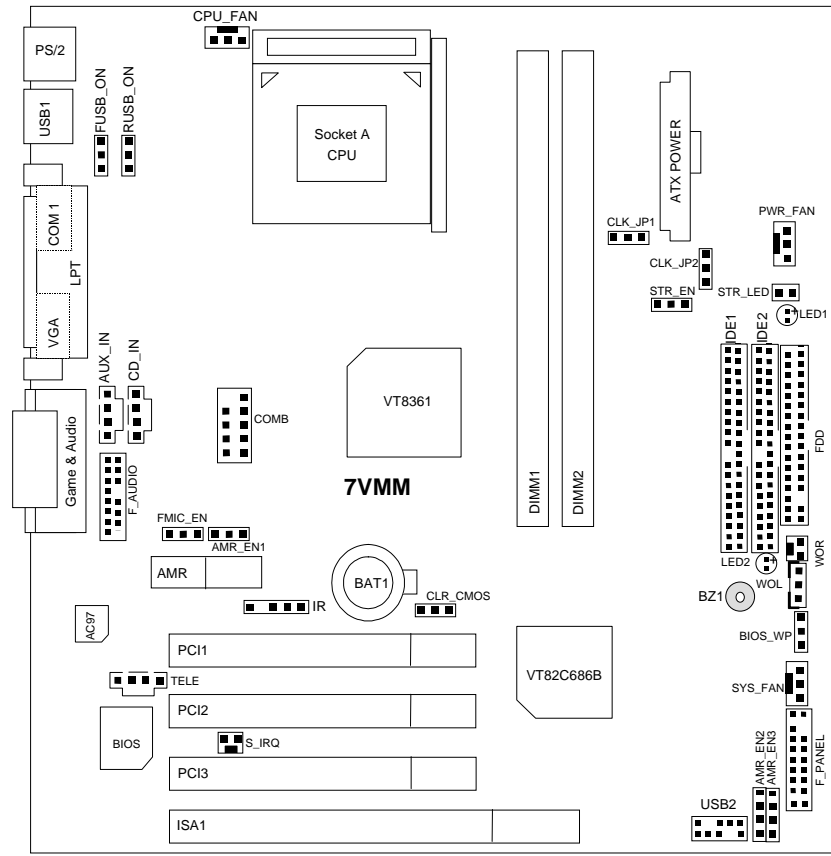

Installation Guide

Getting Started

**WARNING!**

Computer motherboards and expansion cards contain very delicate Integrated Circuit (IC) chips. To protect them against damage from static electricity, you should follow some precautions whenever you work on your computer.

1. Unplug your computer when working on the inside.
2. Use a grounded wrist strap before handling computer components. If you do not have one, touch both of your hands to a safely grounded object or to a metal object, such as the power supply case.
3. Hold components by the edges and try not touch the IC chips, leads or connectors, or other components.
4. Place components on a grounded antistatic pad or on the bag that came with the components whenever the components are separated from the system.
5. Ensure that the ATX power supply is switched off before you plug in or remove the ATX power connector on the motherboard.

Installing the motherboard to the chassis...

If the motherboard has mounting holes, but they don't line up with the holes on the base and there are no slots to attach the spacers, do not become alarmed you can still attach the spacers to the mounting holes. Just cut the bottom portion of the spacers (the spacer may be a little hard to cut off, so be careful of your hands). In this way you can still attach the motherboard to the base without worrying about short circuits. Sometimes you may need to use the plastic springs to isolate the screw from the motherboard PCB surface, because the circuit wire may be near by the hole. Be careful, don't let the screw contact any printed circuit write or parts on the PCB that are near the fixing hole, otherwise it may damage the board or cause board malfunctioning.

To set up your computer, you must complete the following steps:

- ▶ Step 1 - Set system jumpers
- ▶ Step 2- Install the Central Processing Unit (CPU)
- ▶ Step 3-Install memory modules
- ▶ Step 4-Install expansion cards
- ▶ Step 5-Connect ribbon cables, cabinet wires, and power supply
- ▶ Step 6-Set up BIOS software
- ▶ Step 7-Install supporting software tools

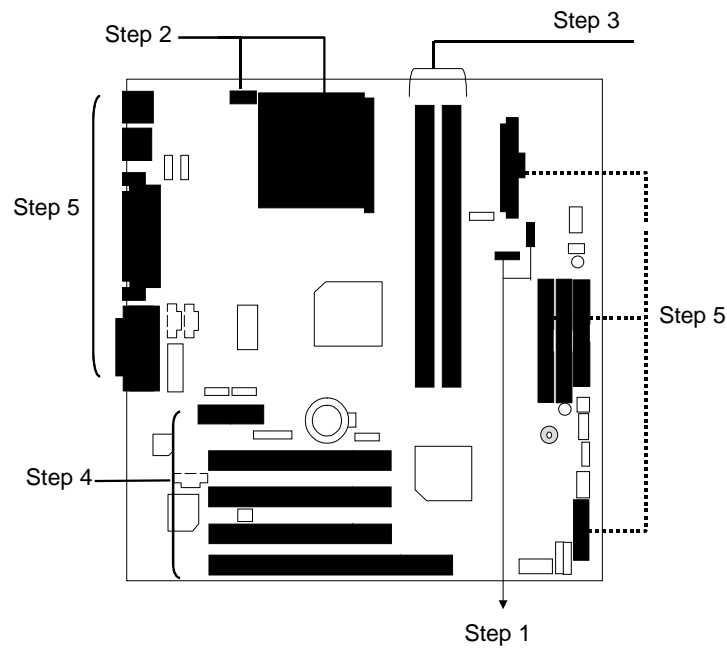

CPU Speed Setup

The system bus speed is selectable at 100/133MHz. The user can select the system bus speed by JUMPER (CLK_JP1/CLK_JP2). (The frequency ratio depend on CPU).

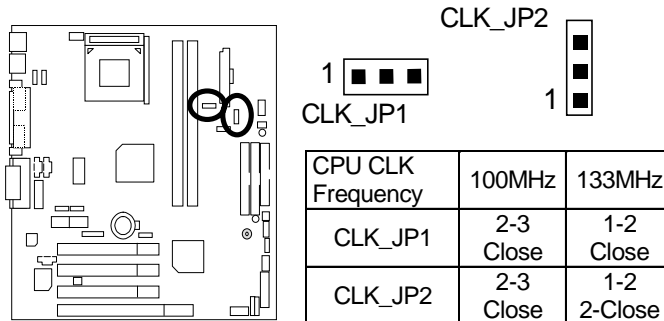

| CPU CLK Frequency | 100MHz | 133MHz |
|-------------------|-----------|-------------|
| CLK_JP1 | 2-3 Close | 1-2 Close |
| CLK_JP2 | 2-3 Close | 1-2 2-Close |

⚠️ AMD CPU Heat Sink Installation:

Beware: Please check that the heat sink is in good contact with the CPU before you turn on your system.

The poor contact will cause over heat, and might cause damage to your processor.

CPU Installation

Please make sure the CPU should be supported to the motherboard.

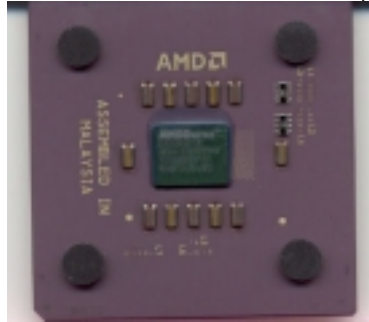

CPU Top View

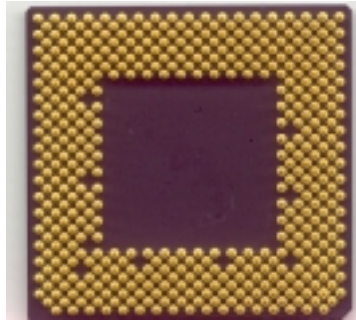

CPU Bottom View

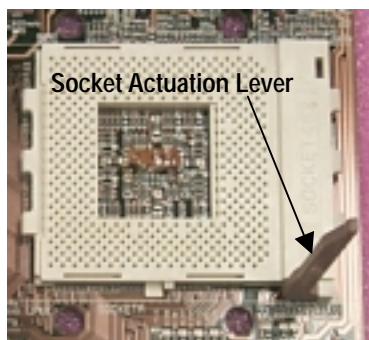

1. Pull the lever out and lift it up.

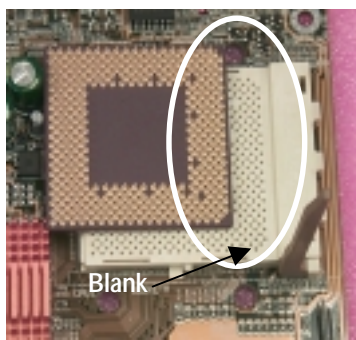

2. The notched corner should be orientated toward the blank space on the socket nearest the lever. The CPU will only fit in the orientation as shown.

CPU Heat Sink Installation:

Beware: Please check that the heat sink is in good contact with the CPU before you turn on your system. **The poor contact will cause over heat, and might cause damage to your processor!**

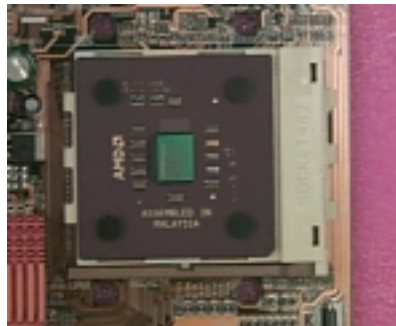

3. Align CPU and insert it
(Please refer to your heatsink installation manual for application of thermal grease to provide better heat conduction between your CPU and heatsink.)



4. Use compliant fan approved by AMD.

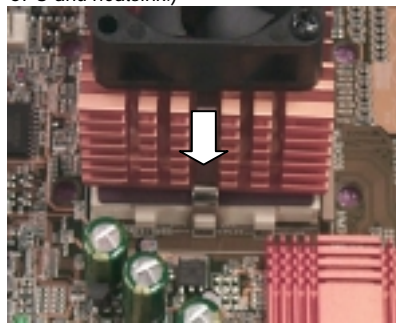

5. Hook one end of the cooler bracket to the CPU socket.

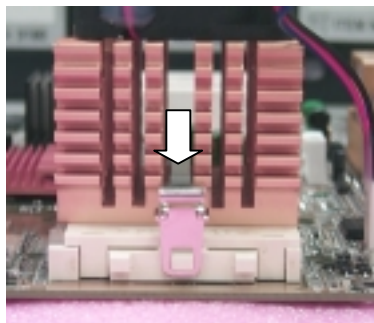

6. Hook the other end of the cooler bracket to the CPU socket.

 (Please refer to the cooler's installation manual for detailed installation steps)

Memory Installation

The motherboard has 2 dual inline memory module (DIMM) sockets support 4 banks. The BIOS will automatically detects memory type and size. To install the memory module, just push it vertically into the DIMM Slot .The DIMM module can only fit in one direction due to the two notch. Memory size can vary between sockets.

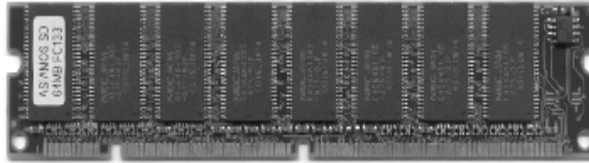

SDRAM

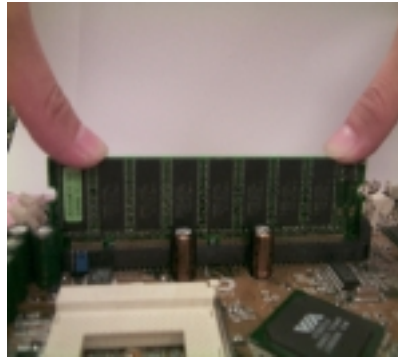
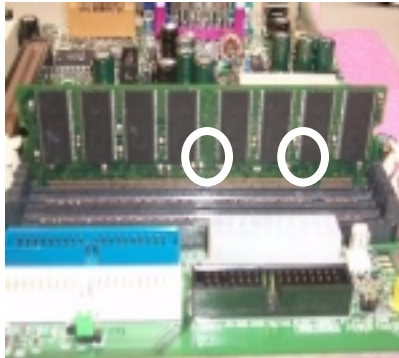

1. The DIMM slot has two notch, so the DIMM memory module can only fit in one direction.
 2. Insert the DIMM memory module vertically into the DIMM slot. Then push it down.
 3. Close the plastic clip at both edges of the DIMM slots to lock the DIMM module.
- ▶ Reverse the installation steps when you wish to remove the DIMM module.

| Page Index for Connectors/Panel and Jumper Definition | Page |
|--|------|
| Connectors | P.13 |
| ATX Power | P.13 |
| AUXIN (AUX_IN) [Optional] | P.17 |
| COM A / VGA / LPT Port | P.13 |
| COM B | P.22 |
| CDIN (CD Audio Line In) | P.17 |
| CPU_FAN (CPU Fan) | P.20 |
| Floppy Port | P.15 |
| F_AUDIO (Front Audio) [Optional] | P.22 |
| Game & Audio Port | P.16 |
| IDE1(Primary),IDE2(Secondary)Port | P.16 |
| IR (IR Header) | P.21 |
| PWR_FAN (Power Fan) | P.19 |
| PS/2 Keyboard & PS/2 Mouse Connector | P.14 |
| SYS_FAN (System 1 Fan) | P.19 |
| STR_LED/LED1 (STR LED Connector & DIMM LED) [Optional] | P.21 |
| S_IRQ (Serial IRQ) | P.23 |
| TELE (TEL) [Optional] | P.18 |
| USB1 (USB Connector) | P.14 |
| USB2 (Front USB Connector) | P.15 |
| WOR (Ring Power On) | P.18 |
| WOL (Wake On LAN) | P.20 |
| Panel and Jumper Definition | P.24 |
| AMR_EN1/AMR_EN2/AMR_EN3 (Onboard AC97 & AMR Selection) | P.27 |
| BAT 1(Battery) | P.28 |
| BIOS_WP (BIOS Write Protection) | P.25 |
| CLR_CMOS (Clear CMOS Function) | P.25 |
| F_PANEL (2x11 pins jumper) | P.24 |
| FMIC_EN (Front MIC) [Optional] | P.27 |
| FUSB (Front USB Device Wake up Selection) | P.28 |
| RUSB (Rear USB Device Wake up Selection) | P.26 |
| STR_EN (STR Selection) [Optional] | P.26 |

Connectors

ATX Power

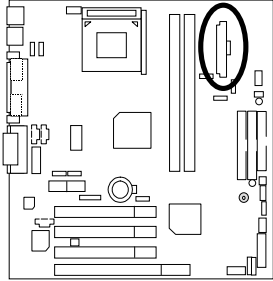

| Pin No. | Definition |
|----------------|--------------------|
| 3,5,7,13,15-17 | GND |
| 1,2,11 | 3.3V |
| 4,6,19,20 | VCC |
| 10 | +12V |
| 12 | -12V |
| 18 | -5V |
| 8 | Power Good |
| 9 | 5V SB stand by+5V |
| 14 | PS-ON(Soft On/Off) |

▲ Please note:
AC power cord should only be connected to your power supply unit after ATX power cable and other related devices are firmly connected to the mainboard.

COM A / VGA / LPT Port

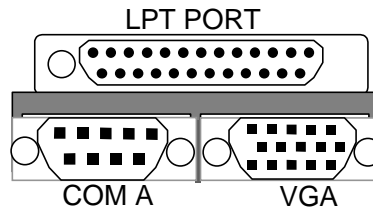
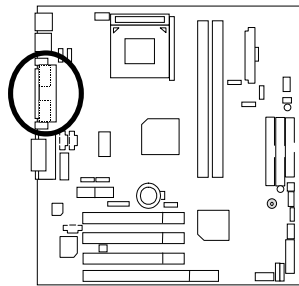

▲ Please note:
This mainboard supports 1 standard COM ports ,1 VGA Port and 1 LPT port.
Device like printer can be connected to LPT port ; mouse and modem etc can be connected to COM ports.

PS/2 Keyboard & PS/2 Mouse Connector

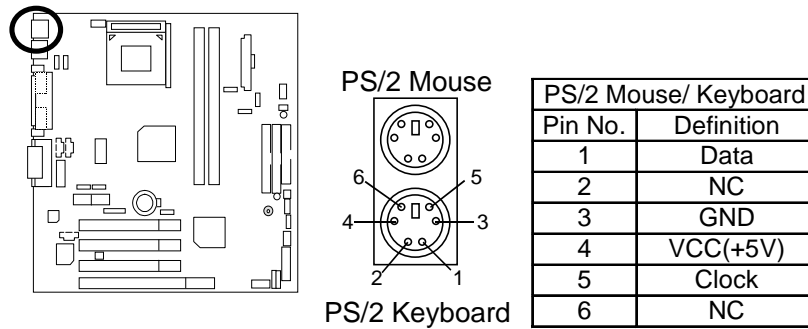

Please note:
 This mainboard supports standard PS/2 keyboard and PS/2 mouse interface connector.

USB1 : USB Connector

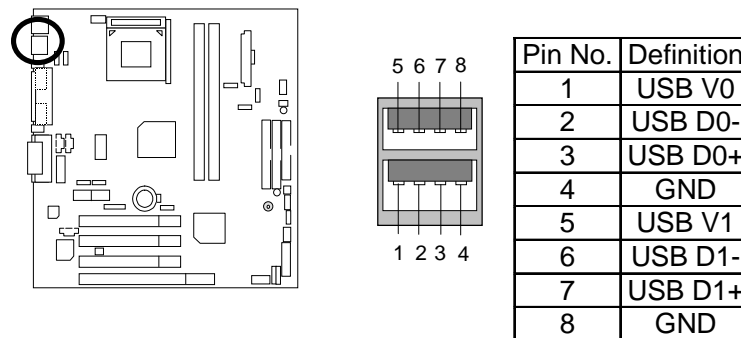

Please note:
 Before you connect your device(s) into USB connector(s), please make sure your device(s) has a standard USB interface like, USB keyboard, mouse, scanner, zip, speaker... Also make sure your OS supports USB controller (Win 95 w/ USB supperment, Win98, Windows 2000, Windows ME, Win NT w/ SP 6). If your OS does not support USB controller, please contact OS vander for passible patch or driver upgrade. For more information please contact your OS or device(s) vanders..

USB2 : Front USB Connector

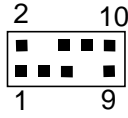
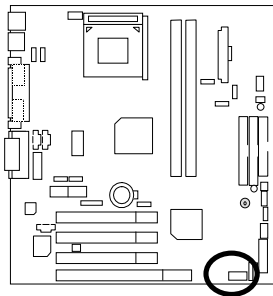

| Pin No. | Definition |
|---------|------------|
| 1 | 5V-SB |
| 2 | GND |
| 3 | USB D2- |
| 4 | NC |
| 5 | USB D2+ |
| 6 | USB D3+ |
| 7 | NC |
| 8 | USB D3- |
| 9 | GND |
| 10 | 5V-SB |



Please note:

Be careful with the polarity of the front panel USB connector. Check the pin assignment while you connect the front panel USB cable. Please contact your nearest dealer for optional front panel USB cable.

Floppy Port

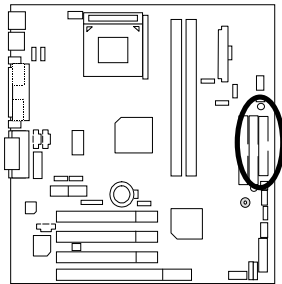

RED LINE

Game & Audio Port

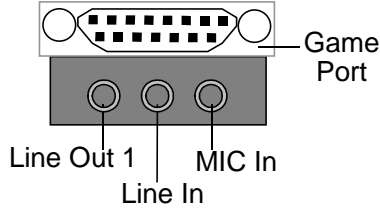
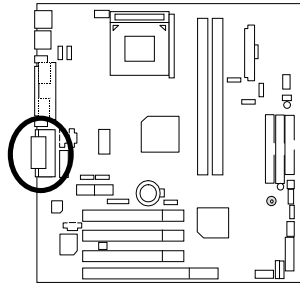

Please note:

This motherboard supports standard audio port and game port. After install onboard audio driver, you may connector speaker to line out jack, micro phone to MIC in jack Device like CD-ROM , walkman etc can be connected to line-in jack

IDE1 (Primary), IDE2 (Secondary) Port

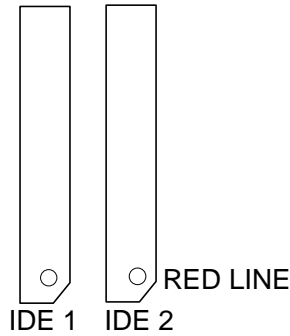
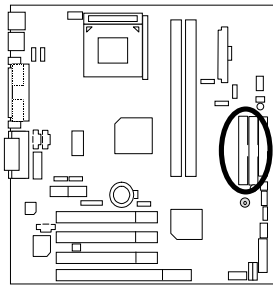

Line Out
capable
or comp
decode
connec
Out aut
To enab
simply t
become
speake

CD_IN : CD Audio Line In

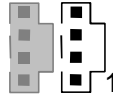
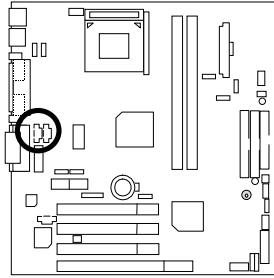

| Pin No. | Definition |
|---------|------------|
| 1 | CD-L |
| 2 | GND |
| 3 | GND |
| 4 | CD-R |

AUX_IN : AUX_IN (Optional)

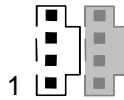
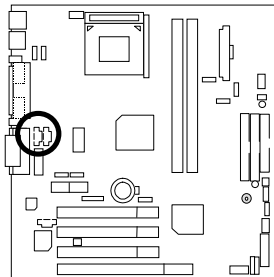

| Pin No. | Definition |
|---------|------------|
| 1 | AUX-L |
| 2 | GND |
| 3 | GND |
| 4 | AUX-R |

TELE : TEL (The connector is for internal modem card with voice connector)(Optional)

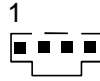
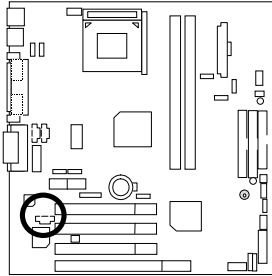

| Pin No. | Definition |
|---------|------------|
| 1 | Signal-In |
| 2 | GND |
| 3 | GND |
| 4 | Signal-Out |

WOR : Ring Power On

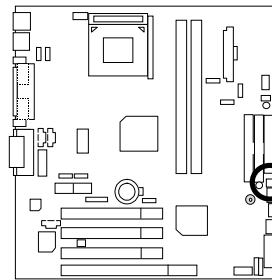

| Pin No. | Definition |
|---------|------------|
| 1 | Signal |
| 2 | GND |

SYS_FAN : System Fan

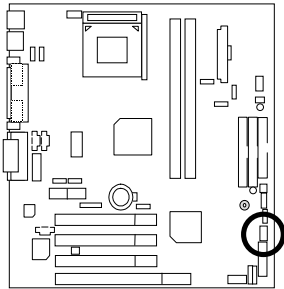

| Pin No. | Definition |
|---------|------------|
| 1 | Control |
| 2 | +12V |
| 3 | SENSE |

PWR_FAN : Power Fan

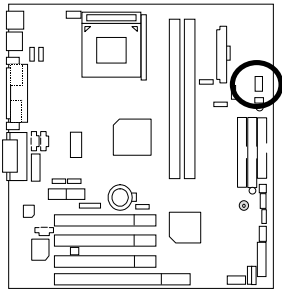

| Pin No. | Definition |
|---------|------------|
| 1 | Control |
| 2 | +12V |
| 3 | SENSE |

CPU_FAN : CPU Fan

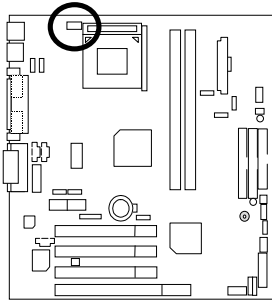

| Pin No. | Definition |
|---------|------------|
| 1 | Control |
| 2 | +12V |
| 3 | SENSE |

**Please note:**

A proper installation of the CPU cooler is essential to prevent the CPU from running under abnormal condition or damaged by overheating.

WOL : Wake on LAN

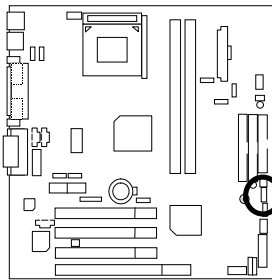

| Pin No. | Definition |
|---------|------------|
| 1 | +5V SB |
| 2 | GND |
| 3 | Signal |

STR_LED/ LED1 : STR LED Connector & DIMM LED (Optional)

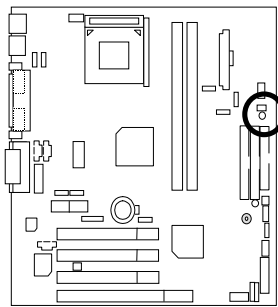

STR LED Connector



DIMM LED



Please note, Do not remove memory modules while DIMM LED is on. It might cause short or other unexpected damages due to the 3.3V stand by voltage. Remove memory modules only when STR function is disabled by jumper and AC Power cord is disconnected.

IR: IR Header

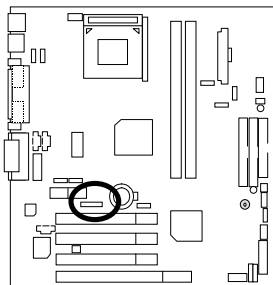

| Pin No. | Definition |
|---------|----------------|
| 1 | VCC (+5V) |
| 2 | NC |
| 3 | IR Data Input |
| 4 | GND |
| 5 | IR Data Output |



Please note: Be careful with the polarity of the IR connector while you connect the IR. Please contact you nearest dealer for optional IR device.

F_AUDIO : Front Audio (Optional)

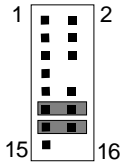
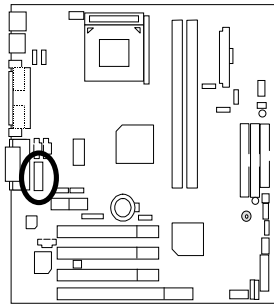

| PIN NO. | Definition |
|----------------|--------------------|
| 1 | Incase speaker (R) |
| 2 | Incase speaker (L) |
| 3, 4,5,6,10,15 | GND |
| 7 | +12V |
| 8,16 | NC |
| 9 | MIC |
| 11 | Front Audio (R) |
| 13 | Front Audio (L) |
| 12 | Rear Audio (R) |
| 14 | Rear Audio (L) |



Please Note : If you want to use "Front Audio" connector, you must move 11-12,13-14 Jumper.

In order to utilize the front audio header, your chassis must have front audio connector. Also please make sure the pin assigment on the cable is the same as the pin assigment on the MB header. To find out if the chassis you are buying support front audio connector, please contact your dealer.

COM B

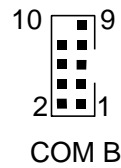
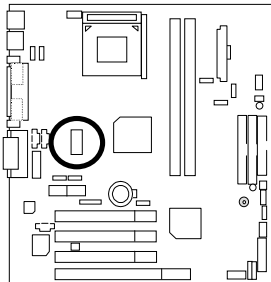

COM B

S_IRQ : Serial IRQ

(For special design, for example: PCMCIA add on card)

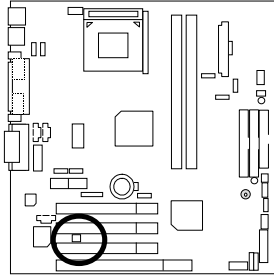

| Pin No. | Definition |
|---------|------------|
| 1 | Signal |
| 2 | GND |

Panel And Jumper Definition

F_PANEL : For 2X11 Pins Jumper

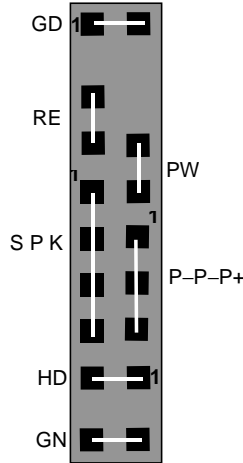
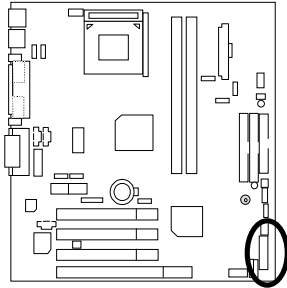

| | |
|-------------------------------|---|
| GN (Green Switch) | Open: Normal Operation Close: Entering Green Mode |
| GD (Green LED) | Pin 1: LED anode(+) Pin 2: LED cathode(-) |
| HD (IDE Hard Disk Active LED) | Pin 1: LED anode(+) Pin 2: LED cathode(-) |
| SPK (Speaker Connector) | Pin 1: VCC(+) Pin 2- Pin 3: NC Pin 4: Data(-) |
| RE (Reset Switch) | Open: Normal Operation Close: Reset Hardware System |
| P+P-P-(Power LED) | Pin 1: LED anode(+) Pin 2: LED cathode(-) Pin 3: LED cathode(-) |
| PW (Soft Power Connector) | Open: Normal Operation Close: Power On/Off |



Please Note: Please connect the power LED, PC speaker, reset switch and power switch etc of your chassis front panel to the front panel jumper according to the pin assignment above.

CLR_CMOS : Clear CMOS Function

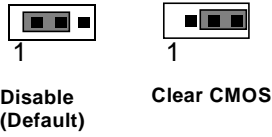
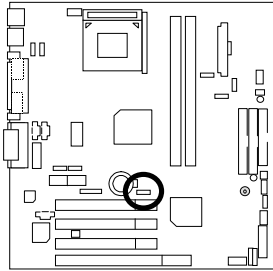

| Pin No. | Definition |
|-----------|---------------------------------------|
| 1-2 Close | Disable Clear CMOS Function (Default) |
| 2-3 Close | Enable Clear CMOS Function |



Please note: You may clear the CMOS data to its default values by this jumper.

BIOS_WP : BIOS Write Protect Function

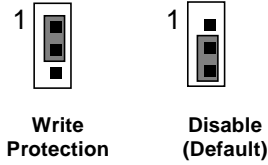
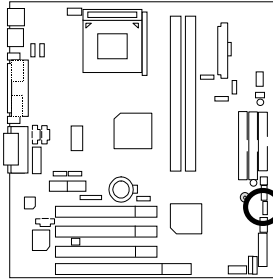

| Pin No. | Definition |
|-----------|---------------------------------|
| 1-2 close | Write Protect Enable |
| 2-3 close | Write Protect Disable (Default) |



Please note: To flash/upgrade BIOS on this MB BIOS_WP jumper must be "2-3 close". We recommend BIOS_WP jumper to be set to "1-2 close", whenever user is not try to flash/upgrade the BIOS.

RUSB_ON: Rear USB Device Wake up Selection
(USB Connector → USB1)

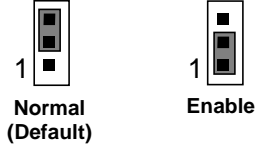
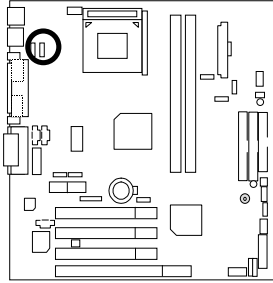

| Pin No. | Definition |
|-----------|---|
| 1-2 close | Rear USB Device Wake up Enable |
| 2-3 close | Rear USB Device Wake up Disable (Default) |



Please note: (If you want to use "USB Dev Wakeup from S4-S5" function, you have to set the BIOS setting "USB Dev Wakeup from S4-S5" enabled, and the jumper "RUSB_ON" & "STR_EN" enabled).

*(Power on the computer and as soon as memory counting starts, press . You will enter BIOS Setup. Select the item "POWER MANAGEMENT SETUP", then select "USB Dev Wakeup from S3-S5: Enabled". Remember to save the setting by pressing "ESC" and choose the "SAVE & EXIT SETUP" option.)

STR_EN : STR Selection (Optional)

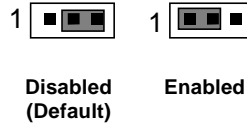
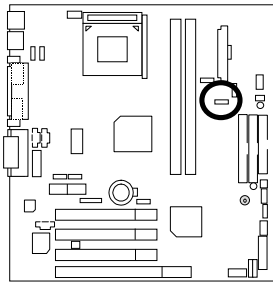

| Pin No. | Definition |
|-----------|------------------------|
| 1-2 close | STR Enabled |
| 2-3 close | STR Disabled (Default) |

AMR_EN1/ AMR_EN2/ AMR_EN3 : Onboard AC97& AMR

(Primary or Secondary) Select (**AMR**→ **Audio Modem Riser**)

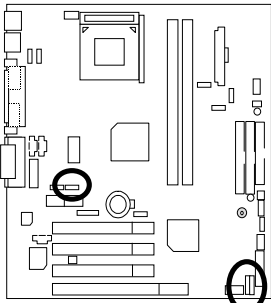



AMR_EN1



AMR_EN2



AMR_EN3

| Jumper Function | AMR_EN1 | AMR_EN2 | AMR_EN3 |
|-------------------------------|--------------|---------------------|--------------|
| Only AC97 | 1-2 Close | 1-2 Close | 1-2 Close |
| Only AMR (Primary) | 2-3 Close | 3-4 Close | 3-4 Close |
| AC97+MR (Secondary) (Default) | 1-2 Close | 1-2 3-4 Close | 1-2 Close |



Please note: This MB supports AMR slot, you can look up the table above to choose the appropriate AMR card for your board.

FMIC_EN : Front MIC (Optional)

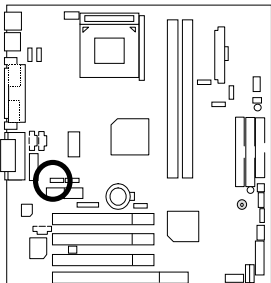



Enabled (Default)



Disabled

| Pin No. | Definition |
|-----------|-------------------|
| 1-2 close | Enabled (Default) |
| 2-3 close | Disabled |

FUSB_ON: Front USB Device Wake up Selection
(USB Connector → USB2)

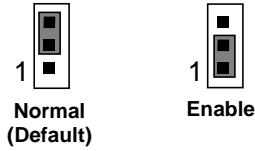
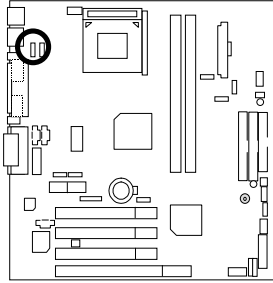

| Pin No. | Definition |
|-----------|--|
| 1-2 close | Front USB Device Wake up Enable |
| 2-3 close | Front USB Device Wake up Disable (Default) |





Please note: (If you want to use "USB Dev Wakeup from S4-S5" function, you have to set the BIOS setting "USB Dev Wakeup from S4-S5" enabled, and the jumper "FUSB_ON" & "STR_EN" enabled).

*(Power on the computer and as soon as memory counting starts, press . You will enter BIOS Setup. Select the item "POWER MANAGEMENT SETUP", then select "USB Dev Wakeup from S3-S5: Enabled". Remember to save the setting by pressing "ESC" and choose the "SAVE & EXIT SETUP" option.)

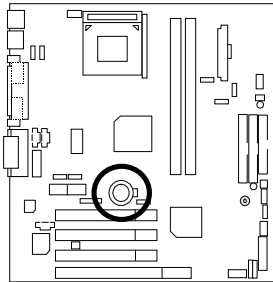
BAT1: Battery



CAUTION

-  Danger of explosion if battery is incorrectly replaced.
-  Replace only with the same or equivalent type recommended by the manufacturer.
-  Dispose of used batteries according to the manufacturer's instructions.

Performance List

The following performance table lists the results of some popular benchmark testing programs. These data are provided as reference only and in no way guarantee the system shall perform, and there is no responsibility for different testing data at exactly the same level. (The different Hardware & Software configuration will result in different benchmark testing results.)

- CPU AMD Althon™ 1333MHz, AMD Duron™ 950MHz
- DRAM (128x2) MB SDRAM (Kingmax)
- CACHE SIZE 384 KB included in Althon™
192 KB included in Duron™
- DISPLAY Onboard AGP
- STORAGE Onboard IDE (Quantum AS30000AT 30GB)
- O.S. Windows 2000 + SP1 + DirectX8.0
- DRIVER Display Driver at 1024 x 768 x 64k colors 75Hz.

| Processor | AMD Althon™ 1333MHz (266x5) | AMD Duron™ 950MHz (200x4.75) |
|--------------------------------|--------------------------------|---------------------------------|
| Winbench99 | | |
| Business Disk Winmark 99 | 6260 | 5950 |
| Hi-End Disk Winmark 99 | 18000 | 17100 |
| Business Graphics Winmark 99 | 607 | 244 |
| Hi-End Graphics Winmark 99 | 1030 | 756 |
| Winstone 2001 | | |
| Business Winstone 2001 | 44.9 | 34.9 |
| Content Creative Winstone 2001 | 59.6 | 46.3 |

☛ If you wish to maximize the performance of your system, please refer to details on P.51

Block Diagram

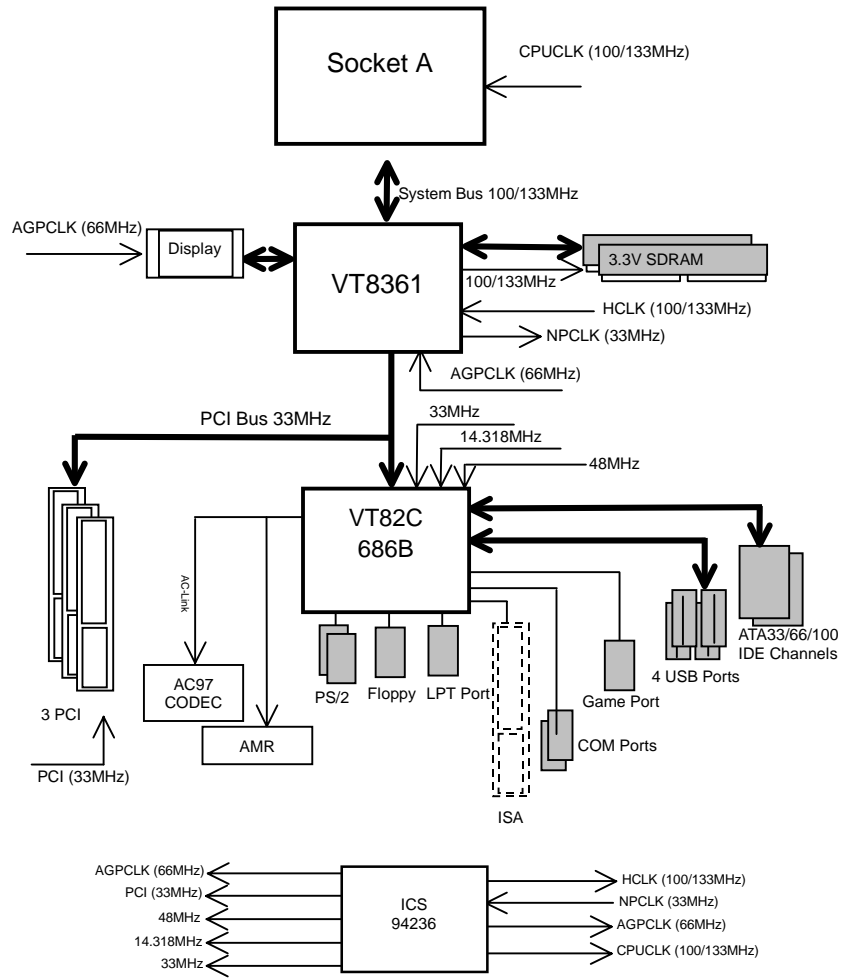

Suspend To RAM Installation (Optional)

A.1 Introduce STR function:

Suspend-to-RAM (STR) is a Windows 98/ME/2000 ACPI sleep mode function. When recovering from STR (S3) sleep mode, the system is able, in just a few seconds, to retrieve the last "state" of the system before it went to sleep and recover to that state. The "state" is stored in memory (RAM) before the system goes to sleep. During STR sleep mode, your system uses only enough energy to maintain critical information and system functions, primarily the system state and the ability to recognize various "wake up" triggers or signals, respectively.

A.2 STR function Installation

Please use the following steps to complete the STR function installation.

Step-By-Step Setup

Step 1:

To utilize the STR function, the system must be in Windows 98/ME/2000 ACPI mode.

Putting Windows 98/ME/2000 into ACPI mode is fairly easy.

Setup with Windows Installation CD-title:

- A. Insert the Windows ME (98/2000) into your CD-ROM drive, select Start, and then Run.
- B. Type (without quotes) "**D:\setup**" in the window provided. Hit the enter key or click OK.
- C. After setup completes, remove the CD, and reboot your system

(This manual assumes that your CD-ROM device drive letter is D:).

Step 2:

(If you want to use STR Function, please set jumper "STR_EN" Pin1-2 (Closed.)

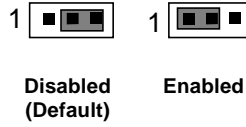
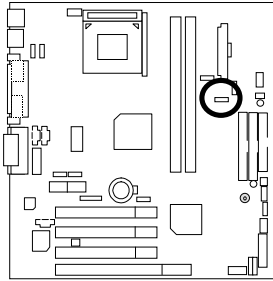

| Pin No. | Definition |
|-----------|------------------------|
| 1-2 close | STR Enabled |
| 2-3 close | STR Disabled (Default) |

Step 3:

Power on the computer and as soon as memory counting starts, press . You will enter BIOS Setup. Select the item "POWER MANAGEMENT SETUP", then select "ACPI Standby State : S3 /STR". Remember to save the settings by pressing "ESC" and choose the "SAVE & EXIT SETUP" option.

Congratulation! You have completed the installation and now can use the STR function.

A.3 How to put your system into STR mode? (For example : Windows ME)

There are two ways to accomplish this:

1. Choose the "Stand by" item in the "Shut Down Windows" area.
 - A. Press the "Start" button and then select "Shut Down"

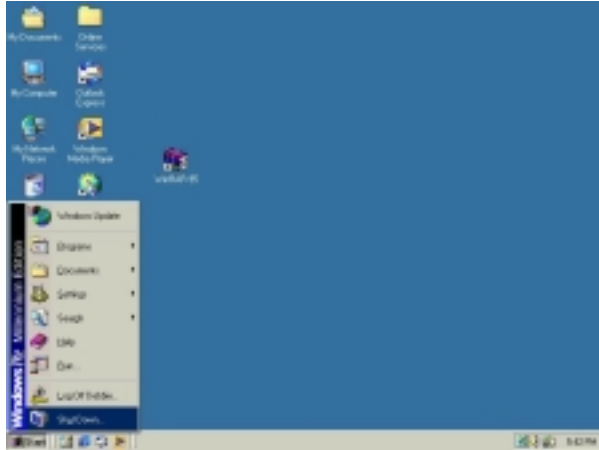

- B. Choose the "Stand by" item and press "OK"



2. Define the system "power on" button to initiate STR sleep mode:
 - A. Double click "My Computer" and then "Control Panel"

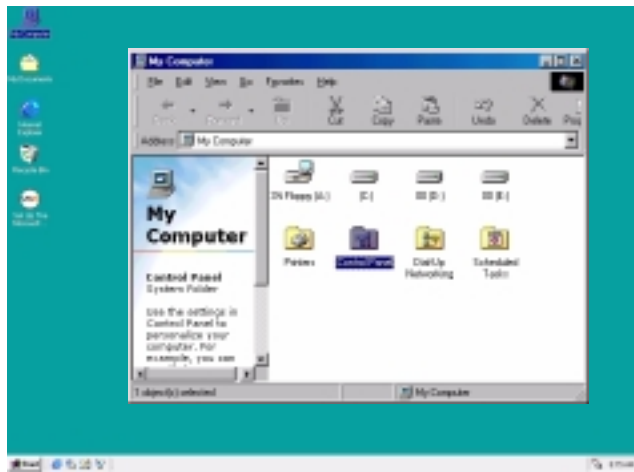

- B. Double click the "Power Management" item.

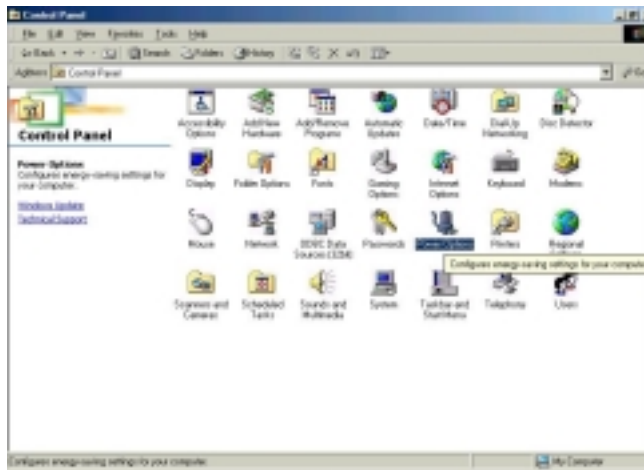

C. Select the "Advanced" tab and "Standby" mode in Power Buttons.

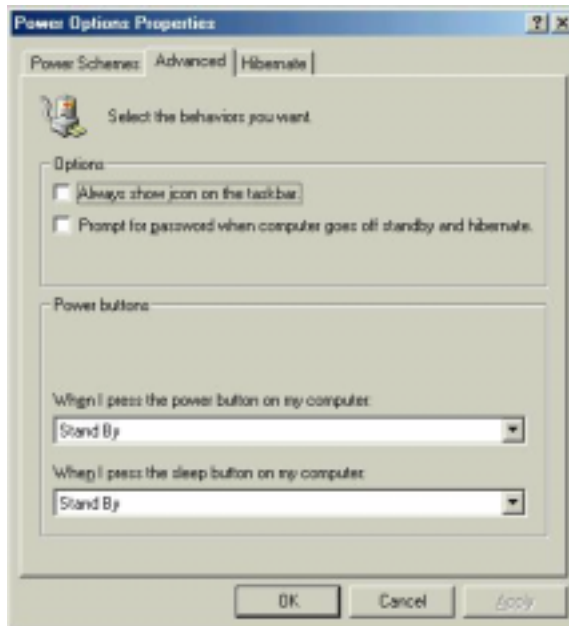

D. Restart your computer to complete setup.

Now when you want to enter STR sleep mode, just momentarily press the "Power on" button..

A.4 How to recover from the STR sleep mode?

There are five ways to "wake up" the system:

1. Press the "Power On" button.
2. Use the "Resume by Alarm" function.
3. Use the "Modem Ring On" function.
4. Use the "Wake On LAN" function.
5. Use the "USB Device Wake Up" function.

A.5 Notices :

1. In order for STR to function properly, several hardware and software requirements must be satisfied:
 - A. Your ATX power supply must comply with the ATX 2.01 specification (provide more than 720 mA 5V Stand-By current).
 - B. Your SDRAM must be PC-100 compliant.
2. Jumper "STR_LED" is provided to connect to the STR LED in your system chassis. [Some chassis may not provide this feature.] The STR LED will be illuminated when your system is in STR sleep mode.

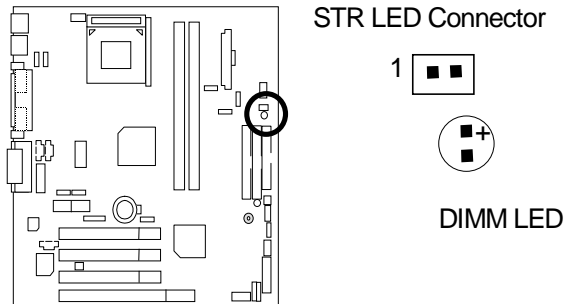

▲ Please note, Do not remove memory modules while DIMM LED is on. It might cause short or other unexpected damages due to the 3.3V stand by voltage. Remove memory modules only when STR function is disabled by jumper and AC Power cord is disconnected.

BIOS Flash Utility Introduction

A. How to use BIOS Flash Utility ?

a. Boot Screen

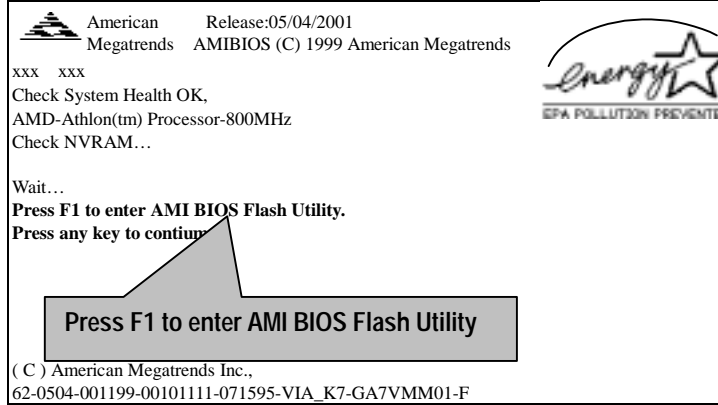

b. AMI BIOS Flash Utility

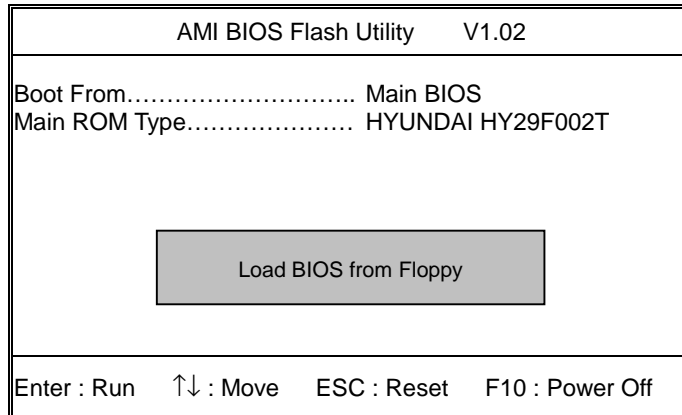

c. In the A: drive, insert the "BIOS" diskette, then Press Enter to Run.

d. Input BIOS file name in the text box. Press "Enter".

Load XXX.XX

Where XXX.XX is name of the BIOS file name.

Are you sure to COPY BIOS?
[Enter] to Continue Or [Esc] to abort..

!! COPY BIOS Completed -Pass !!
Please press any key to continue

Congratulation! You have completed the flashed and now can restart system.

@ BIOS Introduction (Optional)

Gigabyte announces @ BIOS Windows BIOS live update utility



Have you ever updated BIOS by yourself? Or like many other people, you just know what BIOS is, but always hesitate to update it? Because you think updating newest BIOS is unnecessary and actually you don't know how to update it.

Maybe not like others, you are very experienced in BIOS updating and spend quite a lot of time to do it. But of course you don't like to do it too much. First, download different BIOS from website and then switch the operating system to DOS mode. Secondly, use different flash utility to update BIOS. The above process is not a interesting job. Besides, always be carefully to store the BIOS source code correctly in your disks as if you update the wrong BIOS, it will be a nightmare.

Certainly, you wonder why motherboard vendors could not just do something right to save your time and effort and save you from the lousy BIOS updating work? Here it comes! Now Gigabyte announces @BIOS--the first Windows BIOS live update utility. This is a smart BIOS update software. It could help you to download the BIOS from internet and update it. Not like the other BIOS update software, it's a Windows utility. With the help of '@BIOS', BIOS updating is no more than a click.

Besides, no matter which mainboard you are using, if it's a Gigabyte's product*, @BIOS help you to maintain the BIOS. This utility could detect your correct mainboard model and help you to choose the BIOS accordingly. It then downloads the BIOS from the nearest Gigabyte ftp site automatically. There are several different choices: you could use "Internet Update" to download and update your BIOS directly. Or you may want to keep a backup for your current BIOS, just choose "Save Current BIOS" to save it first. You make a wise choice to use Gigabyte, and @BIOS update your BIOS smartly. You are now worry free from updating wrong BIOS, and capable to maintain and manage your BIOS easily. Again, Gigabyte's innovative product erects a milestone in mainboard industries.

For such a wonderful software, how much it costs? Impossible! It's free! Now, if you buy a Gigabyte's motherboard, you could find this amazing software in the attached driver CD. But please remember, connected to internet at first, then you could have a internet BIOS update from your Gigabyte @BIOS.

Easy Tunell™ Introduction (Optional)

Gigabyte announces *EasyTuneIII* Windows overdrive utility



“Overdrive” might be one of the most common issues in computer field. But have many users ever tried it? The answer is probably “no”. Because “overdrive” is thought to be very difficult and includes a lot of technical know-how, sometimes “overdrive” is

even considered as special skills found only in some enthusiasts.

But as to the experts in “overdrive”, what’s the truth? They may spend quite a lot of time and money to study, try and use many different hardware and software tools to do “overdrive”. And even with these technologies, they still learn that it’s quite a risk because the safety and stability of an “overdrive” system is unknown.

Now everything is different because of a Windows overdrive utility EasyTuneIII--announced by Gigabyte. This utility has totally changed the gaming rule of “overdrive”. This is the first overdrive utility suitable for both normal and power users. Users can choose either “Easy Mode” or “Advanced Mode” to run “overdrive” at their convenience. For users who choose “Easy Mode”, they just need to click “Auto Optimize” to have auto and immediate CPU overclocking. This software will then overdrive CPU speed automatically with the result being shown in the control panel. If someone prefers to “overdrive” by oneself, there is also another choice. Click “Advanced Mode” to enjoy “sport drive” class overclocking. In “Advanced Mode”, one can change the system bus speed in small increments to get ultimate system performance. And no matter which mainboard is used, if it’s a Gigabyte’s product*, EasyTuneIII helps to perform the best of system.

Besides, different from other traditional over-clocking methods, EasyTuneIII doesn’t require users to change neither BIOS nor hardware switch/ jumper setting; on the other hand, they can do “overdrive” at only one click. Therefore, this is a safer way for “overdrive” as nothing is changed on software or hardware. If user runs EasyTuneIII over system’s limitation, the biggest lost is only to restart the computer again and the side effect is then well controlled. Moreover, if one well-performed system speed been tested in EasyTuneIII, user can “Save” this bus speed and “Load” it in next time. Obviously, Gigabyte EasyTuneIII has already turned the “overdrive” technology toward to a newer generation.

This wonderful software is now free bundled in Gigabyte motherboard attached driver CD. Users may make a test drive of "EasyTuneIII™" to find out more amazing features by themselves.

For further technical information, please link to: <http://www.gigabyte.com.tw>

※ Note: For the latest version of EasyTuneIII™, please visit our website.

| Page Index for BIOS Setup | Page |
|-------------------------------|------|
| The Main Menu | P.44 |
| Standard CMOS Setup | P.46 |
| BIOS Features Setup | P.49 |
| Chipset Features Setup | P.51 |
| Power Management Setup | P.53 |
| PNP/ PCI Configuration | P.56 |
| Load Fail-Safe Defaults | P.58 |
| Load Optimized Defaults | P.59 |
| Integrated Peripherals | P.60 |
| Hardware Monitor & MISC Setup | P.64 |
| Supervisor / User Password | P.65 |
| IDE HDD Auto Detection | P.66 |
| Save & Exit Setup | P.67 |
| Exit Without Saving | P.68 |

BIOS Setup

BIOS Setup is an overview of the BIOS Setup Interface. The interface allows users to modify the basic system configuration, which is stored in battery-backed CMOS RAM so that it retains the Setup information can be retained when the power is turned off.

ENTERING SETUP

Power ON the computer and press immediately will allow you to enter Setup. If unsuccessful, you can restart the system and try again by pressing the "RESET" button on the system case. You may also restart by simultaneously pressing <Ctrl> – <Alt>– keys.

CONTROL KEYS

| | |
|----------|--|
| <↑> | Move to previous item |
| <↓> | Move to next item |
| <←> | Move to the item in the left hand |
| <→> | Move to the item in the right hand |
| <Esc> | Main Menu - Quit and not save changes into CMOS Status Page Setup Menu and Option Page Setup Menu - Exit current page and return to Main Menu |
| <+/PgUp> | Increase the numeric value or make changes |
| <-/PgDn> | Decrease the numeric value or make changes |
| <F1> | General help, only for Status Page Setup Menu and Option Page Setup Menu |
| <F2> | Reserved |
| <F3> | Reserved |
| <F4> | Reserved |
| <F5> | Restore the previous CMOS value from CMOS, only for Option Page Setup Menu |
| <F6> | Load the default CMOS value from BIOS default table, only for Option Page Setup Menu |
| <F7> | Load the Optimized Defaults |
| <F8> | Reserved |
| <F9> | Reserved |
| <F10> | Save all the CMOS changes, only for Main Menu |

GETTING HELP

Main Menu

The on-line description of the highlighted setup function is displayed at the bottom of the screen.

Status Page Setup Menu / Option Page Setup Menu

Press F1 to pop up a small help window that describes the appropriate keys to use and the possible selections for the highlighted item. To exit the Help Window press <Esc>.

The Main Menu (For Example : BIOS Version 7VMM.F2C)

Once you enter AMI BIOS CMOS Setup Utility, the Main Menu (Figure 1) will appear on the screen. The Main Menu allows you to select from nine setup functions and two exit choices. Use arrow keys to select among the items and press <Enter> to accept or enter the sub-menu.

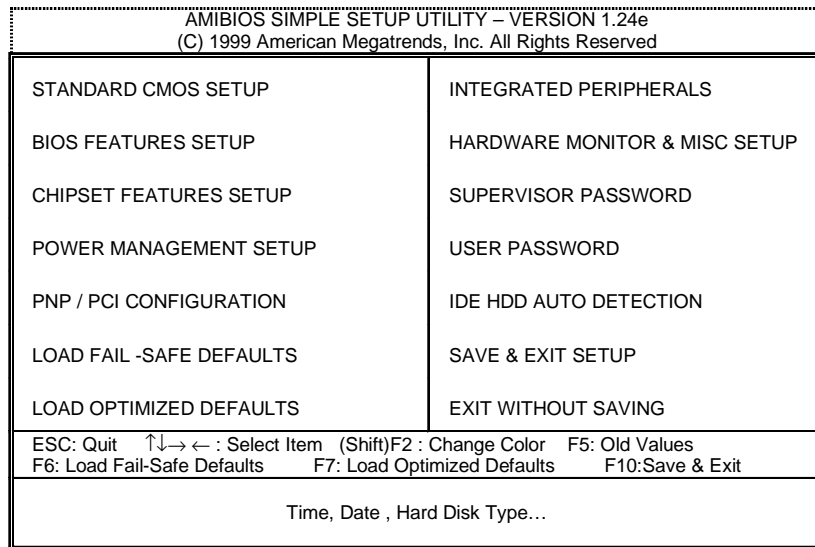

Figure 1: Main Menu

- **Standard CMOS Setup**
This setup page includes all the adjustable items in standard compatible BIOS.
- **BIOS Features Setup**
This setup page includes all the adjustable items of Award special enhanced features.

- **Chipset Features Setup**

This setup page includes all the adjustable items of chipset special features.
- **Power Management Setup**

This setup page includes all the adjustable items of Green function features.
- **PnP/PCI Configurations**

This setup page includes all the adjustable configurations of PCI & PnP ISA resources.
- **Load Fail-Safe Defaults**

Load Fail-Safe Defaults option loads preset system parameter values to set the system in its most stable configurations.
- **Load Optimized Defaults**

Load Optimized Defaults option loads preset system parameter values to set the system in its highest performance configurations.
- **Integrated Peripherals**

This setup page includes all onboard peripherals.
- **Hardware Monitor Setup**

This setup page is auto detect fan and temperature status.
- **Set Supervisor Password**

Set Change or disable password. It allows you to limit access to the system and/or BIOS setup.
- **Set User Password**

Set Change or disable password. It allows you to limit access to the system.
- **IDE HDD auto detection**

Automatically configure hard disk parameters.
- **Save & Exit Setup**

Save CMOS value settings to CMOS and exit setup.
- **Exit Without Saving**

Abandon all CMOS value changes and exit setup.

Standard CMOS Setup

The items in Standard CMOS Setup Menu (Figure 2) are divided into 10 categories. Each category includes none, one or more than one setup items. Use the arrows to highlight the item and then use the <PgUp> or <PgDn> keys to select the value in each item.

| AMIBIOS SETUP – STANDARD CMOS SETUP | | | | | | | |
|--|-------------|-------------|-------------|-------------------------|----------------|--------------|---------------|
| (C) 1999 American Megatrends, Inc. All Rights Reserved | | | | | | | |
| Date (mm/dd/yyyy) : Thu Feb 17, 2000 | | | | | | | |
| Time (hh/mm/ss) : 14:44:35 | | | | | | | |
| | <u>TYPE</u> | <u>SIZE</u> | <u>CYLS</u> | <u>HEAD</u> | <u>PRECOMP</u> | <u>LANDZ</u> | <u>SECTOR</u> |
| Pri Master | : Auto | | | | | | |
| Pri Slave | : Auto | | | | | | |
| Sec Master | : Auto | | | | | | |
| Sec Slave | : Auto | | | | | | |
| Floppy Drive A : 1.44 MB 3½ | | | | Base Memory : 640 Kb | | | |
| Floppy Drive B : Not Installed | | | | Other Memory : 384 Kb | | | |
| Boot Sector Virus Protection : Disabled | | | | Extended Memory : 63 Mb | | | |
| | | | | Total Memory : 64 Mb | | | |
| Month : Jan – Dec | | | | ESC : Exit | | | |
| Day : 01– 31 | | | | ↑↓ : Select Item | | | |
| Year : 1990 – 2099 | | | | PU / PD / + / – :Modify | | | |
| | | | | (Shift) F2 : Color | | | |

Figure 2: Standard CMOS Setup

- **Date**

The date format is <Week>, <Month> <Day> <Year>.

| | |
|-------|---|
| Week | The week, from Sun to Sat, determined by the BIOS and is display-only |
| Month | The month, Jan. Through Dec. |
| Day | The day, from 1 to 31 (or the maximum allowed in the month) |
| Year | The year, from 1990 through 2099 |

- **Time**

The times format in <hour> <minute> <second>. The time is calculated base on the 24-hour military-time clock. For example, 1 p.m. is 13:00:00.

- **Primary Master / Slave , Secondary Master / Slave**

The category identifies the type of hard disk from drive C to F that has been installed in the computer. There are two settings: Auto, and Manual. Manual: HDD type is user-definable; Auto will automatically detect HDD type.

Note that the specifications of your drive must match with the drive table. The hard disk will not work properly if you enter improper information for this category.

If you select User Type, related information will be asked to enter to the following items. Enter the information directly from the keyboard and press <Enter>. Such information should be provided in the documentation form your hard disk vendor or the system manufacturer.

| | |
|----------|---------------------|
| CYLS. | Number of cylinders |
| HEADS | number of heads |
| PRECOMP | write precomp |
| LANDZONE | Landing zone |
| SECTORS | number of sectors |

If a hard disk has not been installed select NONE and press <Enter>.

- **Floppy Drive A type / Drive B**

The category identifies the type of floppy disk drive A or drive B that has been installed in the computer.

| | |
|----------------|---|
| None | No floppy drive installed. |
| 360K, 5.25 in. | 5.25 inch PC-type standard drive; 360K byte capacity. |
| 1.2M, 5.25 in. | 5.25 inch AT-type high-density drive; 1.2M byte capacity (3.5 inch when 3 Mode is Enabled). |
| 720K, 3.5 in. | 3.5 inch double-sided drive; 720K byte capacity. |
| 1.44M, 3.5 in. | 3.5 inch double-sided drive; 1.44M byte capacity. |
| 2.88M, 3.5 in. | 3.5 inch double-sided drive; 2.88M byte capacity. |

- **Boot Sector Virus Protection**

If it is set to enable, the category will flash on the screen when there is any attempt to write to the boot sector or partition table of the hard disk drive. The system will halt and the following error message will appear in the mean time. You can run anti-virus program to locate the problem.

| | |
|----------|---|
| Enabled | Activate automatically when the system boots up causing a warning message to appear when anything attempts to access the boot sector or hard disk partition table |
| Disabled | No warning message to appear when anything attempts to access the boot sector or hard disk partition table (Default Value) |

- **Memory**

The category is display-only which is determined by POST (Power On Self Test) of the BIOS.

Base Memory

The POST of the BIOS will determine the amount of base (or conventional) memory installed in the system.

The value of the base memory is typically 512 K for systems with 512 K memory installed on the motherboard, or 640 K for systems with 640 K or more memory installed on the motherboard.

Other Memory

This refers to the memory located in the 640 K to 1024 K address space. This is memory that can be used for different applications.

DOS uses this area to load device drivers to keep as much base memory free for application programs. Most use for this area is Shadow RAM.

Extended Memory

The BIOS determines how much extended memory is present during the POST. This is the amount of memory located above 1 MB in the CPU's memory address map.

BIOS Features Setup

| AMIBIOS SETUP – BIOS FEATURES SETUP | |
|--|----------|
| (C) 1999 American Megatrends, Inc. All Rights Reserved | |
| 1st Boot Device | Floppy |
| 2nd Boot Device | IDE-0 |
| 3rd Boot Device | CDROM |
| S.M.A.R.T. for Hard Disks | Disabled |
| BootUp Num-Lock | On |
| Floppy Drive Seek | Disabled |
| Password Check | Setup |
| ESC : Quit ↑↓→← : Select Item F1 : Help PU/PD+/-/ : Modify F5 :Old Values (Shift)F2:Color F6 : Load Fail-Safe Defaults F7 : Load Optimized Defaults | |

Figure 3: BIOS Features Setup

- **1st / 2nd / 3rd Boot Device**

| | |
|----------------|--|
| Floppy | Set your boot device priority to Floppy. |
| ZIP A: /LS 120 | Set your boot device priority to LS/ ZIP A:. |
| CDROM | Set your boot device priority to CDROM. |
| SCSI | Set your boot device priority to SCSI. |
| NETWORK | Set your boot device priority to NETWORK. |
| IDE-0-IDE-3 | Set your boot device priority to IDE-0-IDE-3. |
| Disabled | Disable this function. |
| ATAPI ZIP C: | Set your boot device priority to ATAPI ZIP C:. |

- **S.M.A.R.T. for Hard Disks**

| | |
|----------|---|
| Enabled | Enabled S.M.A.R.T. Feature for Hard Disks. |
| Disabled | Disabled S.M.A.R.T. Feature for Hard Disks (Default Value) |

- **Boot Up Num-Lock**

| | |
|-----|---|
| On | Keypad is number keys. (Default Value) |
| Off | Keypad is arrow keys. |

- **Floppy Drive Seek**

During POST, BIOS will determine if the floppy disk drive installed is 40 or 80 tracks. 360 type is 40 tracks while 720, 1.2 and 1.44 are all 80 tracks.

| | |
|----------|---|
| Enabled | BIOS searches for floppy disk drive to determine if it is 40 or 80 tracks. Note that BIOS can't differentiate between from 720, 1.2 or 1.44 drive type as they are all 80 tracks. |
| Disabled | BIOS will not search for the type of floppy disk drive by track number. Note that there will not be any warning message if the drive installed is 360. (Default Value) |

- **Password Check**

 Please refer to the detail on P.65

| | |
|--------|--|
| Setup | The user must enter correct password in order to access BIOS setup utility. (Default Value) |
| Always | The user must enter correct password in order to access the system and/or BIOS Setup. |

Chipset Features Setup

 We would not suggest you change the chipset default setting unless you really need it.

| AMIBIOS SETUP – CHIPSET FEATURES SETUP (C) 1999 American Megatrends, Inc. All Rights Reserved | |
|--|--------------|
| Top Performance | Disabled |
| Configure Timing by SPD | Enabled |
| DRAM Frequency | Auto |
| SDRAM CAS# Latency | Auto |
| AGP Mode | 4X |
| AGP Aperture Size | 64MB |
| ClkGen Spread Spectrum | Enabled |
| USB Controller | All USB Port |
| USB Legacy Support | Disabled |
| ESC : Quit ↑↓→← : Select Item F1 : Help PU/PD+/-/ : Modify F5 :Old Values (Shift)F2:Color F6 : Load Fail-Safe Defaults F7 : Load Optimized Defaults | |

Figure 4: Chipset Features Setup

- **Top Performance**

If you wish to maximize the performance of your system, set "Top Performance" to "Enabled".

| | |
|----------|---|
| Disabled | Disable Top Performance. (Default Value) |
| Enabled | Top Performance Enabled. |

- **Configure Timing by SPD**

| | |
|----------|--|
| Disabled | Configure Timing by SPD Function Disabled. |
| Enabled | Configure Timing by SPD Function Enabled. (Default Value) |

- **DRAM Frequency**

| | |
|--------|---|
| 100MHz | Set DRAM Frequency to 100MHz. |
| 133MHz | Set DRAM Frequency to 133MHz |
| Auto | Set RAM Frequency automatically. (Default Value) |

- **SDRAM CAS# Latency**

| | |
|------|--|
| 2 | For Fastest SDRAM DIMM module. |
| 3 | For Slower SDRAM DIMM module. |
| Auto | Set SDRAM CAS# Latency automatically. (Default Value) . |

- **AGP Mode**

| | |
|----|--|
| 4X | Set AGP Mode to 4X. (Default Value) |
| 1X | Set AGP Mode to 1X. |
| 2X | Set AGP Mode to 2X. |

- **AGP Aperture Size**

| | |
|-------|--|
| 4MB | Set AGP Aperture Size to 4MB. |
| 8MB | Set AGP Aperture Size to 8 MB. |
| 16MB | Set AGP Aperture Size to 16 MB. |
| 32MB | Set AGP Aperture Size to 32 MB. |
| 64MB | Set AGP Aperture Size to 64 MB. (Default Value) |
| 128MB | Set AGP Aperture Size to 128 MB. |
| 256MB | Set AGP Aperture Size to 256 MB. |

- **ClkGen Spread Spectrum**

| | |
|----------|--|
| Disabled | Disabled ClkGen Spread Spectrum. |
| Enabled | Enabled ClkGen Spread Spectrum. (Default Value) |

- **USB Controller**

| | |
|--------------|---|
| USB Port 0&1 | USB Controller for USB Port 0&1. |
| USB Port 2&3 | USB Controller for USB Port 2&3. |
| All USB Port | USB Controller for All USB Port. (Default Value) |
| Disabled | USB Controller Function Disabled. |

- **USB Legacy Support**

| | |
|--------------|--|
| Keyboard/FDD | Set USB Legacy Support Keyboard / Floppy. |
| KB/Mouse/FDD | Set USB Legacy Support Keyboard / Mouse /Floppy. |
| Disabled | Disabled USB Legacy Support Function. (Default Value) |

Power Management Setup

| AMBIOS SETUP – POWER MANAGEMENT SETUP (C) 1999 American Megatrends, Inc. All Rights Reserved | | | |
|---|-------------|------------------------------|--------------------|
| *ACPI Standby State | S1/POS | RTC Alarm Hour | 12 |
| **USB Dev Wakeup From S4~S5 | Disabled | RTC Alarm Minute | 30 |
| Suspend Time Out(Minute) | Disabled | RTC Alarm Second | 30 |
| Display Activity | Ignore | | |
| IRQ3 | Monitor | | |
| IRQ4 | Monitor | | |
| IRQ5 | Ignore | | |
| IRQ7 | Monitor | | |
| IRQ9 | Ignore | | |
| IRQ10 | Ignore | | |
| IRQ11 | Ignore | | |
| IRQ13 | Ignore | | |
| IRQ14 | Monitor | | |
| IRQ15 | Ignore | | |
| Soft-Off by Power Button | Instant-Off | | |
| System after AC Back | Last State | ESC : Quit | ↑↓→← : Select Item |
| Resume On Ring/LAN | Enabled | F1 : Help | PU/PD+/-/ : Modify |
| Resume On PME# | Enabled | F5:Old Values | (Shift)F2:Color |
| Resume On RTC Alarm | Disabled | F6 : Load Fail-Safe Defaults | |
| RTC Alarm Date | 15 | F7 : Load Optimized Defaults | |

Figure 5: Power Management Setup

* This item will be shown only on m/bs with STR function.

** The item "USB Dev Wake-up from S3~S5" will be shown only on m/bs with STR function

- **ACPI Standby State**

| | |
|--------|--|
| S1/POS | Set ACPI Standby State is S1 (Default Value) |
| S3/STR | Set ACPI Standby State is S3. |

- **USB Dev Wakeup From S4~S5**

| | |
|----------|---|
| Enabled | Enable USB Device Wakeup From S4~S5. |
| Disabled | Disable USB Device Wakeup From S4~S5. (Default value) |

- **Suspend Time Out (Minute)**



System enters suspend power state when the length of period selected by this optional has expired.

| | |
|---------------|--|
| Disabled | Disable the timer to enter suspend mode. (Default Value) |
| 30Sec ~ 1Hour | Set the timer to enter suspend mode. |

- **Display Activity**

| | |
|---------|---|
| Ignore | Ignore Display Activity. (Default Value) |
| Monitor | Monitor Display Activity. |

- **IRQ 3-IRQ15**

| | |
|---------|---------------------|
| Ignore | Ignore IRQ3 -IRQ15. |
| Monitor | Monitor IRQ3-IRQ15. |

- **Soft-off by Power Button**

| | |
|-------------|--|
| Instant-off | The user press the power button once, he can turn off the system. (Default Value) |
| Delay 4 sec | The user press the power button once, then he can enter suspend mode. |

- **System after AC Back**

| | |
|------------|--|
| Off | When AC-power back to the system, the system will be in "Off" state. |
| On | When AC-power back to the system, the system will be in "On" state. |
| Last State | When AC-power back to the system, the system will return to the Last state before AC-power off. (Default Value) |

- **Resume On Ring / LAN**

| | |
|----------|---|
| Disabled | Disable resume on ring / LAN function. |
| Enabled | The modem ring / LAN wake up will bring the system out of soft-off or suspend state if this option is set "Enabled". (Default Value) |

- **Resume On PME#**

| | |
|----------|--|
| Disabled | Disable PME Event Wake Up. |
| Enabled | The PME event wake up will bring the system out of soft-off or suspend state if this option is set "Enabled". (Default Value) |

- **Resume On RTC Alarm**

You can set "Resume On RTC Alarm" item to enabled and key in Data/time to power on system.

| | |
|----------|---|
| Disabled | Disable this function. (Default Value) |
| Enabled | Enable alarm function to POWER ON system. |

If RTC Alarm Lead To Power On is Enabled.

| | |
|--------------------|----------------|
| RTC Alarm Date : | Every Day,1~31 |
| RTC Alarm Hour: | 0~23 |
| RTC Alarm Minute : | 0~59 |
| RTC Alarm Second : | 0~59 |

PNP/PCI Configuration

| AMBIOS SETUP – PNP / PCI CONFIGURATION | |
|--|-----------|
| (C) 1999 American Megatrends, Inc. All Rights Reserved | |
| VGA Frame Buffer Size | : 8MB |
| VGA Boot From | : PCI |
| PCI Slot 1 IRQ Priority | : Auto |
| PCI Slot 2 IRQ Priority | : Auto |
| PCI Slot 3 IRQ Priority | : Auto |
| IRQ-3 | : PCI/PnP |
| IRQ-4 | : PCI/PnP |
| IRQ-5 | : PCI/PnP |
| IRQ-7 | : PCI/PnP |
| IRQ-9 | : PCI/PnP |
| IRQ-10 | : PCI/PnP |
| IRQ-11 | : PCI/PnP |
| IRQ-14 | : PCI/PnP |
| IRQ-15 | : PCI/PnP |
| ESC: Quit ↑↓→←: Select Item F1 : Help PU/PD+/-: Modify F5 :Old Values(Shift)F2:Color F6 : Load Fail-Safe Defaults F7 : Load Optimized Defaults | |

Figure 6: PNP/ PCI Configuration

- **VGA Frame Buffer Size**

| | |
|-----|--|
| 2MB | Set VGA Frame buffer size to 2MB. |
| 4MB | Set VGA Frame buffer size to 4MB. |
| 8MB | Set VGA Frame buffer size to 8MB. (Default Value) . |

- **VGA Boot From**

| | |
|-----|--|
| AGP | Set VGA Boot from AGP VGA Card. |
| PCI | Set VGA Boot from PCI VGA Card. (Default Value) |

- **PCI Slot 1 / 2 / 3 IRQ Priority**

| | |
|------|---|
| Auto | The system will reserved a free IRQ for PCI slot 1 / 2 / 3 device. (Default Value) |
| 3 | The system will reserved IRQ3 for PCI slot 1 / 2 / 3 device if no legacy ISA device using IRQ3. |
| 4 | The system will reserved IRQ for PCI slot 1 / 2 / 3 device if no legacy ISA device using IRQ4. |
| 5 | The system will reserved IRQ5 for PCI slot 1 / 2 / 3 device if no legacy ISA device using IRQ5. |

| | |
|----|---|
| 7 | The system will reserved IRQ7 for PCI slot 1 / 2 / 3 device if no legacy ISA device using IRQ7. |
| 9 | The system will reserved IRQ9 for PCI slot 1 / 2 / 3 device if no legacy ISA device using IRQ9. |
| 10 | The system will reserved IRQ10 for PCI slot 1 / 2 / 3 device if no legacy ISA device using IRQ10. |
| 11 | The system will reserved IRQ11 for PCI slot 1 / 2 / 3 device if no legacy ISA device using IRQ11. |

- **IRQ (3,4,5,7,9,10,11,14,15)**

| | |
|----------|--|
| ISA/EISA | The resource reserved for Legacy ISA device. |
| PCI/PnP | The resource can be assigned to PCI/ PnP device. |

Load Fail-Safe Defaults

| | |
|--|---------------------------------|
| AMIBIOS SIMPLE SETUP UTILITY-VERSION 1.24e (C) 1999 American Megatrends, Inc. All Rights Reserved | |
| STANDARD CMOS SETUP | INTEGRATED PERIPHERALS |
| BIOS FEATURES SETUP | HARDWARE MONITOR & MISC SETUP |
| CHIPSET FEATURES SETUP | SUPERVISOR PASSWORD |
| POWER MANAGEMENT SETUP | USER PASSWORD |
| PNP/PCI CONFIGURATION | LOAD FAIL-SAFE DEFAULTS (Y/N)?N |
| LOAD FAIL-SAFE DEFAULTS | SAVE & EXIT SETUP |
| LOAD OPTIMIZED DEFAULTS | EXIT WITHOUT SAVING |
| ESC : Quit ↑↓→← : Select Item (Shift) F2 : Change Color F5 : Old Values F6 : Load Fail-Safe Defaults F7: Load Optimized Defaults F10: Save & Exit | |
| Load Fail-Safe Defaults except Standard CMOS SETUP | |

Figure 7: Load Fail-Safe Defaults

- **Load Fail-Safe Defaults**

Fail-Safe defaults contain the most appropriate system parameter values of to configure the system to achieve maximum stability.

Load Optimized Defaults

| AMBIOS SIMPLE SETUP UTILITY-VERSION 1.24e (C) 1999 American Megatrends, Inc. All Rights Reserved | |
|--|---------------------------------|
| STANDARD CMOS SETUP | INTEGRATED PERIPHERALS |
| BIOS FEATURES SETUP | HARDWARE MONITOR & MISC SETUP |
| CHIPSET FEATURES SETUP | SUPERVISOR PASSWORD |
| POWER MANAGE | Load Optimized Defaults (Y/N)?N |
| PNP/PCI CONFIG | |
| LOAD FAIL-SAFE DEFAULTS | SAVE & EXIT SETUP |
| LOAD OPTIMIZED DEFAULTS | EXIT WITHOUT SAVING |
| ESC : Quit ↑↓→← : Select Item (Shift) F2 : Change Color F5 : Old Values F6 : Load Fail-Safe Defaults F7: Load Optimized Defaults F10: Save & Exit | |
| Load Optimized Defaults except Standard CMOS SETUP | |

Figure 8: Load Optimized Defaults

- **Load Optimized Defaults**

Optimized defaults contain the most appropriate system parameter values to configure the system to achieve maximum performance.

Integrated Peripherals

| AMIBIOS SETUP –INTEGRATED PERIPHERAL (C) 1999 American Megatrends, Inc. All Rights Reserved | | | |
|--|------------|------------------------------|--------------------|
| OnBoard FDC | :Auto | Game Port(200h-207h) | :Enabled |
| OnBoard Serial Port 1 | :Auto | | |
| OnBoard Serial Port 2 | :Auto | | |
| Serial Port 2 Mode | :Normal | | |
| Duplex Mode | :N/A | | |
| OnBoard Parallel Port | :Auto | | |
| Parallel Port Mode | :ECP | | |
| Parallel Port DMA | :Auto | | |
| Parallel Port IRQ | :Auto | | |
| OnBoard IDE | :Both | | |
| OnBoard AC'97 Audio | :Auto | | |
| OnBoard MC'97 Modem | :Auto | | |
| OnBoard Legacy Audio | :Enabled | | |
| Sound Blaster | :Disabled | | |
| SB I/O Base Address | :220h-22Fh | ESC : Quit | ↑↓←→: Select Item |
| SB IRQ Select | : 5 | F1 : Help | PU/PD/+/- : Modify |
| SB DMA Select | : 1 | F5 : Old Values | (Shift)F2 :Color |
| MPU-401 | :Disabled | F6 : Load Fail-Safe Defaults | |
| MPU-401 I/O Address | :330h-333h | F7 : Load Optimized Defaults | |

Figure 9: Integrated Peripherals

- **OnBoard FDC**

| | |
|----------|--|
| Disabled | Disable this function. |
| Enabled | Enable onboard floppy disk controller. |
| Auto | Set the floppy disk controller automatically. (Default Value) |

- **OnBoard Serial Port 1**

| | |
|----------|--|
| Auto | BIOS will automatically setup the port A address. (Default Value) |
| 3F8/COM1 | Enable onboard Serial port A and address is 3F8. |
| 2F8/COM2 | Enable onboard Serial port A and address is 2F8. |
| 3E8/COM3 | Enable onboard Serial port A and address is 3E8. |
| 2E8/COM4 | Enable onboard Serial port A and address is 2E8. |
| Disabled | Disable onboard Serial port A. |

- **OnBoard Serial Port 2**

| | |
|----------|--|
| Auto | BIOS will automatically setup the port 2 address. (Default Value) |
| 3F8/COM1 | Enable onboard Serial port 2 and address to 3F8. |
| 2F8/COM2 | Enable onboard Serial port 2 and address to 2F8. |
| 3E8/COM3 | Enable onboard Serial port 2 and address to 3E8. |
| 2E8/COM4 | Enable onboard Serial port 2 and address to 2E8. |
| Disabled | Disable onboard Serial port 2. |

- **Serial Port 2 Mode**

| | |
|--------|--|
| Normal | Normal operation. (Default Value) |
| IrDA | Onboard I/O chip supports IRDA |
| ASK IR | Onboard I/O chip supports ASK IR. |

- **OnBoard Parallel port**

| | |
|----------|--|
| 378 | Set onboard LPT port and address to 378. |
| 278 | Set onboard LPT port and address to 278. |
| 3BC | Set onboard LPT port and address to 3BC. |
| Auto | Set onboard LPT port automatically. (Default Value) . |
| Disabled | Disable this function. |

- **Parallel Port Mode**

| | |
|--------|---|
| EPP | Using Parallel port as Enhanced Parallel Port. |
| ECP | Using Parallel port as Extended Capabilities Port. (Default Value) |
| Normal | Normal Operation. |

- **Parallel Port DMA**

| | |
|------|---|
| 3 | Set Parallel Port DMA to 3. |
| 1 | Set Parallel Port DMA to 1. |
| 0 | Set Parallel Port DMA to 0. |
| Auto | Set Parallel Port DMA automatically. (Default Value) |

- **Parallel Port IRQ**

| | |
|------|---|
| 7 | Set Parallel Port IRQ to 7. |
| 5 | Set Parallel Port IRQ to 5. |
| Auto | Set Parallel Port IRQ automatically. (Default Value) |

- **OnBoard IDE**

| | |
|-----------|---|
| Disabled | Disabled onboard IDE |
| Both | Set onboard IDE is Both. (Default Value) |
| Primary | Set onboard IDE is Primary. |
| Secondary | Set onboard IDE is Secondary. |

- **OnBoard AC'97 Audio**

| | |
|----------|---|
| Auto | Set onboard AC'97 Audio to Auto. (Default Value) |
| Disabled | Disabled onboard AC'97 Audio. |

- **OnBoard MC'97 Modem**

| | |
|----------|---|
| Auto | Set onboard MC'97 Modem to Auto. (Default Value) |
| Disabled | Disabled onboard MC'97 Modem. |

- **OnBoard Legacy Audio**

| | |
|----------|--|
| Enabled | Enabled onboard Legacy Audio. (Default Value) |
| Disabled | Disabled onboard Legacy Audio. |

- **Sound Blaster**

| | |
|----------|--|
| Enabled | Enabled Sound Blaster. |
| Disabled | Disabled Sound Blaster. (Default Value) |

- **SB I/O Base Address**

| | |
|-----------|--|
| 220h-22Fh | Set SB I/O Base Address is 220h-22Fh. (Default Value) |
| 280h-28Fh | Set SB I/O Base Address is 280h-28Fh. |
| 260h-26Fh | Set SB I/O Base Address is 260h-26Fh. |
| 240h-24Fh | Set SB I/O Base Address is 240h-24Fh. |

- **SB IRQ Select**

| |
|---|
| IRQ 5 / 7 / 9 / 10. (Default Value: 5) |
|---|

- **SB DMA Select**

| |
|--|
| DMA 0 / 1 / 2 / 3. (Default Value: 1) |
|--|

- **MPU-401**

| | |
|----------|--|
| Enabled | Enabled MPU-401. |
| Disabled | Disabled MPU-401. (Default Value) |

- **MUP-401 I/O Address**

| | |
|-----------|--|
| 330h-333h | Set MUP-401 I/O Address is 330h-333h. (Default Value) |
| 300h-303h | Set MUP-401 I/O Address is 300h-303h. |
| 310h-313h | Set MUP-401 I/O Address is 310h-313h. |
| 320h-323h | Set MUP-401 I/O Address is 320h-323h. |

- **Game Port (200h-207h)**

| | |
|----------|---|
| Disabled | Disabled Game Port (200h-207h). |
| Enabled | Enabled Game Port (200h-207h). (Default Value) |

Hardware Monitor & MISC Setup

| AMIBIOS SETUP – HARDWARE MONITOR & MISC SETUP | |
|--|-----------|
| (C) 1999 American Megatrends, Inc. All Rights Reserved | |
| CPU Temperature | 32°C/89°F |
| System Temperature | 32°C/89°F |
| CPU Fan Speed | 7123 RPM |
| System Fan Speed | 0 RPM |
| Vcore | 1.6 V |
| Vdd | 3.3 V |
| Vcc3 | 3.312 V |
| +5.000V | 5.030 V |
| +12.000V | 11.923 V |
| ESC: Quit ↑↓→←: Select Item F1 : Help PU/PD+/-/: Modify F5 :Old Values (Shift)F2:Color F6 : Load Fail-Safe Defaults F7 : Load Optimized Defaults | |

Figure 10: Hardware Monitor & MISC Setup

- **CPU Temperature. (°C / °F)**
Detect CPU Temperature automatically.
- **System Temperature. (°C / °F)**
Detect System Temperature automatically.
- **CPU FAN Speed**
Detect CPU Fan speed status automatically .
- **System FAN Speed**
Detect System Fan speed status automatically .
- **Voltage (V) Vcore / Vdd / Vcc3 / +5V / +12V**
Detect system's voltage status automatically.

Supervisor / User Password

When you select this function, the following message will appear at the center of the screen to assist you in creating a password.

| AMIBIOS SIMPLE SETUP UTILITY-VERSION 1.24e (C) 1999 American Megatrends, Inc. All Rights Reserved | |
|--|--------------------------------|
| STANDARD CMOS SETUP | INTEGRATED PERIPHERALS |
| BIOS FEATURES SETUP | HARDWARE MONITOR & MISC SETUP |
| CHIPSET FEATURES SETUP | SUPERVISOR PASSWORD |
| POWER MANAGE | Enter new supervisor password: |
| PNP/PCI CONFIGURATION | |
| LOAD FAIL-SAFE DEFAULTS | SAVE & EXIT SETUP |
| LOAD OPTIMIZED DEFAULTS | EXIT WITHOUT SAVING |
| ESC : Quit ↑↓→← : Select Item (Shift) F2 : Change Color F5 : Old Values F6 : Load Fail-Safe Defaults F7 : Load Optimized Defaults F10 : Save & Exit | |
| Change / Set / Disable Password | |

Figure 11: Password Setting

Type the password, up to six characters, and press <Enter>. You will be asked to confirm the password. Type the password again and press <Enter>. You may also press <Esc> to abort the selection and not enter a password.

To disable password, just press <Enter> when you are prompted to enter password. A message "**PASSWORD DISABLED**" will appear to confirm the password being disabled. Once the password is disabled, the system will boot and you can enter Setup freely.

The BIOS Setup program allows you to specify two separate passwords: a **SUPERVISOR PASSWORD** and a **USER PASSWORD**. When disabled, anyone may access all BIOS Setup program function. When enabled, the Supervisor password is required for entering the BIOS Setup program and having full configuration fields, the User password is required to access only basic items.

If you select "**Always**" at "**Password Check**" in BIOS Features Setup Menu, you will be prompted for the password every time the system is rebooted or any time you try to enter Setup Menu.

If you select "**Setup**" at "**Password Check**" in BIOS Features Setup Menu, you will be prompted only when you try to enter Setup.

IDE HDD Auto Detection

| AMIBIOS SETUP – STANDARD CMOS SETUP | | | | | | |
|--|-------------|------------------|------|------------------------|---------|--------------|
| (C) 1999 American Megatrends, Inc. All Rights Reserved | | | | | | |
| Date (mm/dd/yyyy) : Tue Jan 18, 2000 | | | | | | |
| Time (hh/mm/ss) : 10:36:24 | | | | | | |
| | TYPE | SIZE | CYLS | HEAD | PRECOMP | LANDZ SECTOR |
| MODE | | | | | | |
| Pri Master : Auto | | | | | | |
| Pri Slave : Auto | | | | | | |
| Sec Master : Auto | | | | | | |
| Sec Slave : Auto | | | | | | |
| Floppy Drive A: 1.44 MB 3 ½ | | | | Base Memory : 640 kb | | |
| Floppy Driver B: Not Installed | | | | Other Memory : 384 kb | | |
| Boot Sector Virus Protection : Disabled | | | | Extended Memory : 31mb | | |
| | | | | Total Memory : 32mb | | |
| Month: | Jan – Dec | ESC : Exit | | | | |
| Day: | 01 – 31 | ↑↓ : Select Item | | | | |
| Year : | 1990 – 2099 | /PD/+/- : Modify | | | | |
| | | Shift)F2 : Color | | | | |

Figure 12: IDE HDD Auto Detection

Type "Y" will accept the H.D.D. parameter reported by BIOS.

Type "N" will keep the old H.D.D. parameter setup. If the hard disk cylinder number is over 1024, then the user can select LBA mode or LARGER mode for DOS partition larger than 528 MB.

Save & Exit Setup

| | |
|--|-------------------------------|
| AMIBIOS SIMPLE SETUP UTILITY-VERSION 1.24e (C) 1999 American Megatrends, Inc. All Rights Reserved | |
| STANDARD CMOS SETUP | INTEGRATED PERIPHERALS |
| BIOS FEATURES SETUP | HARDWARE MONITOR & MISC SETUP |
| CHIPSET FEATURES SETUP | SUPERVISOR PASSWORD |
| POWER MANAGEMENT | |
| PNP/PCI CONFIGURATION | |
| LOAD FAIL-SAFE DEFAULTS | SAVE & EXIT SETUP |
| LOAD OPTIMIZED DEFAULTS | EXIT WITHOUT SAVING |
| ESC : Quit ↑↓→← : Select Item (Shift) F2 : Change Color F5 : Old Values F6 : Load Fail-Safe Defaults F7 : Load Optimized Defaults F10 : Save & Exit | |
| Save Data to CMOS & Exit SETUP | |

Figure 13: Save & Exit Setup

Type "Y" will quit the Setup Utility and save the user setup value to RTC CMOS.

Type "N" will return to Setup Utility.

Exit Without Saving

| | |
|---|-------------------------------|
| AMBIOS SIMPLE SETUP UTILITY-VERSION 1.24e (C) 1999 American Megatrends, Inc. All Rights Reserved | |
| STANDARD CMOS SETUP | INTEGRATED PERIPHERALS |
| BIOS FEATURES SETUP | HARDWARE MONITOR & MISC SETUP |
| CHIPSET FEATURES SETUP | SUPERVISOR PASSWORD |
| POWER MANAGEMENT SETUP | USER PASSWORD |
| PNP/PCI CONFIGURATION | LOAD FAIL-SAFE DEFAULTS |
| LOAD OPTIMIZED DEFAULTS | SAVE & EXIT SETUP |
| | EXIT WITHOUT SAVING |
| ESC : Quit ↑↓→← : Select Item (Shift) F2 : Change Color F5 : Old Values F6 : Load Fail-Safe Defaults F7: Load Optimized Defaults F10: Save & Exit | |
| Abandon all Datas & Exit SETUP | |

Figure 14: Exit Without Saving

Type "Y" will quit the Setup Utility and save the user setup value to RTC CMOS.

Type "N" will return to Setup Utility.

Technical Support /RMA Sheet

| | | |
|------------------------|---------------|---------------|
| Customer/Country: | Company: | Phone No.: |
| Contact Person: | E-mail Add. : | |
| Model name/Lot Number: | | PCB revision: |
| BIOS version: | O.S./A.S.: | |

| Hardware Configuration | Mfs. | Model name | Size: | Driver/Utility: |
|------------------------|------|------------|-------|-----------------|
| CPU | | | | |
| Memory Brand | | | | |
| Video Card | | | | |
| Audio Card | | | | |
| HDD | | | | |
| CD-ROM / DVD-ROM | | | | |
| Modem | | | | |
| Network | | | | |
| AMR / CNR | | | | |
| Keyboard | | | | |
| Mouse | | | | |
| Power supply | | | | |
| Other Device | | | | |
| | | | | |
| | | | | |

Problem Description:

Appendix

Appendix A: VIA VT8601/8361 Chipsets Driver Installation

Insert the support CD that came with your motherboard into your CD-ROM driver or double-click the CD driver icon in My Computer to bring up the screen.



Appendix B: VT8601/8361 Chipset Drivers

Insert the support CD that came with your motherboard into your CD-ROM driver or double-click the CD driver icon in My Computer to bring up the screen.

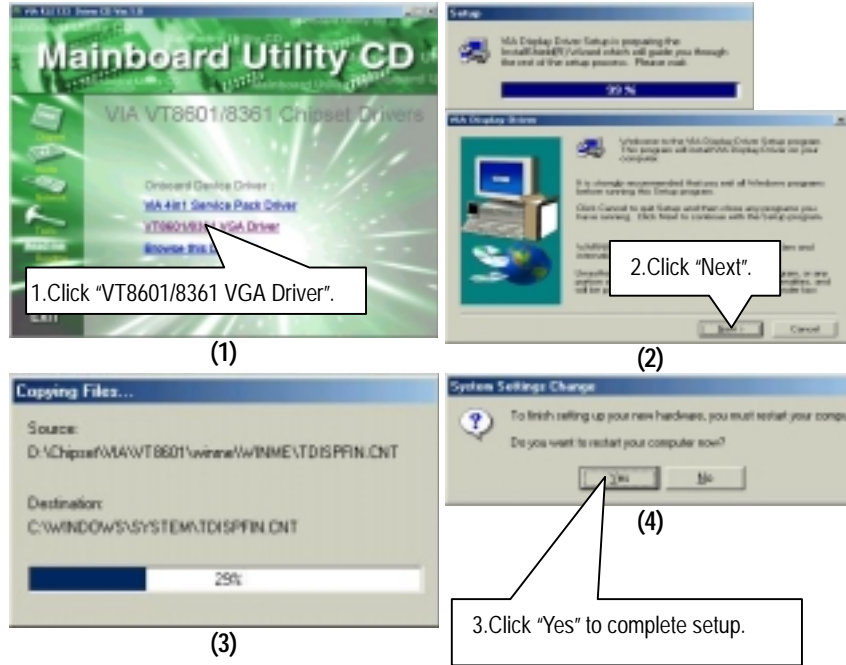

Appendix C: VIA AC'97 Audio Driver

Insert the support CD that came with your motherboard into your CD-ROM driver or double-click the CD driver icon in My Computer to bring up the screen.

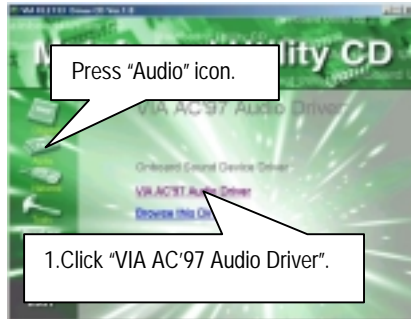

(1)



(2)

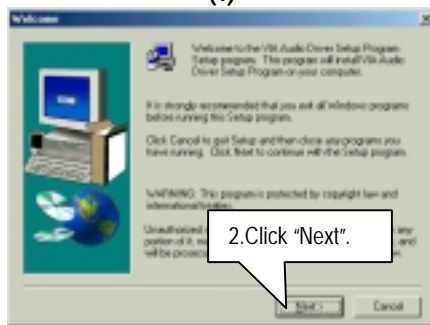

(3)

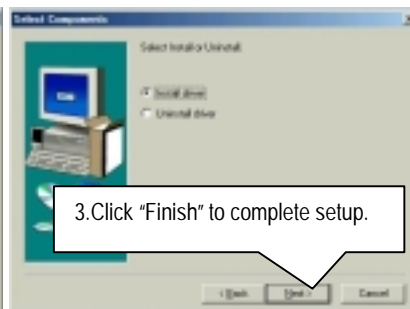

(4)

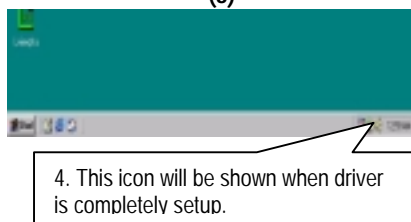

(5)

Appendix D: BIOS Flash Procedure

BIOS update procedure:

If your OS is Win9X, we recommend that you used Gigabyte @BIOS Program to flash BIOS.

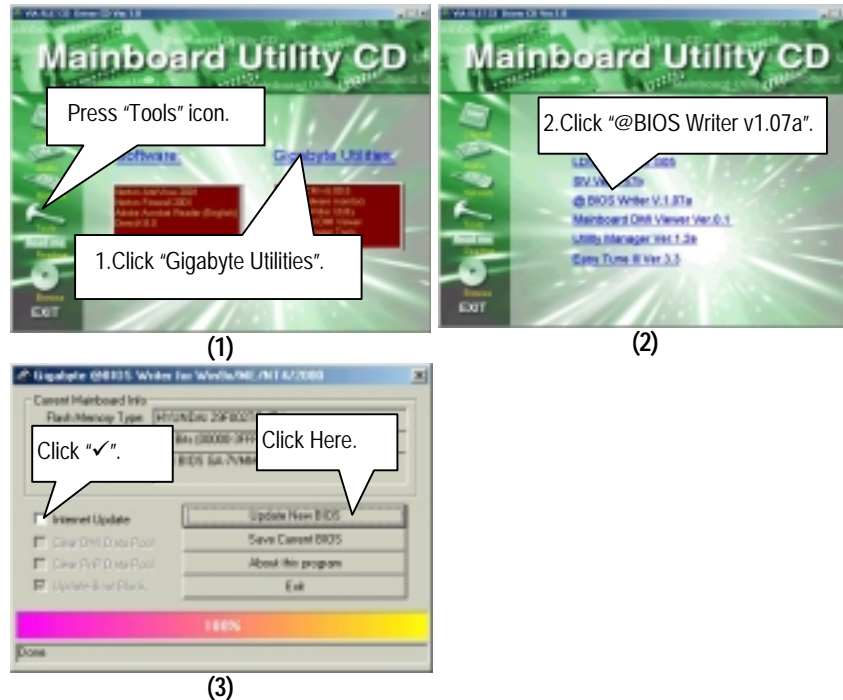

Methods and steps:

- I. Update BIOS through Internet
 - a. Click "Internet Update" icon
 - b. Click "Update New BIOS" icon
 - c. Select @BIOS sever ("Gigabyte @BIOS sever 1 in Taiwan" and "Gigabyte @BIOS sever 2 in Taiwan" are available for now, the others will be completed soon)
 - d. Select the exact model name on your motherboard
 - e. System will automatically download and update the BIOS.

II. Update BIOS **NOT** through Internet:

- a. **Do not** click "Internet Update" icon
- b. Click "Update New BIOS"
- c. Please select "All Files" in dialog box while opening the old file.
- d. Please search for BIOS unzip file, downloading from internet or any other methods (such as: 7VMM.F1).
- e. Complete update process following the instruction.

III. Save BIOS

In the very beginning, there is "Save Current BIOS" icon shown in dialog box. It means to save the current BIOS version.

IV. Check out supported motherboard and Flash ROM:

In the very beginning, there is "About this program" icon shown in dialog box. It can help you check out which kind of motherboard and which brand of Flash ROM are supported.

Note:

- a. In method I, if it shows two or more motherboard's model names to be selected, please make sure your motherboard's model name again. Selecting name will cause the system unbooted.
- b. In method II, be sure that motherboard's model name in BIOS unzip file are the same as your motherboard's. Otherwise, your system won't boot.
- c. In method I, if the BIOS file you need cannot be found in @BIOS server, please go onto Gigabyte's web site for downloading and updating it according to method II.
- d. Please note that any interruption during updating will cause system unbooted

Or else you can select flash BIOS in DOS mode.

☛ Please check your **BIOS vendor (AMI or AWARD)**, your **motherboard name** and **PCB version** on the motherboard.

1. Format a bootable system floppy diskette by the command "**format a:/s**" in command mode.
2. Visit the Gigabyte website at [http:// www.gigabyte.com.tw](http://www.gigabyte.com.tw) , Select the BIOS file you need and download it to your bootable floppy diskette.
3. Insert the bootable diskette containing the BIOS file into the floppy diskette driver.
4. Assuming that the floppy diskette driver is A, reboot the system by using the A: driver. At the A: > prompt, run the BIOS upgraded file by executing the Flash BIOS utility and the BIOS file with its appropriate extension.

Example: *(AMI tool) (Where 7VMM.f1 is name of the BIOS file name)*

A:>flashxxx.exe 7VMM.f1 ↵

Example: *(Award tool) (Where 7VMM.f1 is name of the BIOS file name)*

A:>Awdflash.exe 7VMM.f1 ↵

5. Upon pressing the <Enter> key, a flash memory writer menu will appear on screen. Enter the new BIOS file name with its extension filename into the text box after file name to program.
6. If you want to save the old BIOS file(perform as soon as system is operational, this is recommended), select Y to **DO YOU WANT TO SAVE BIOS**, then type the old BIOS filename and the extension after filename to save: This option allows you to copy the contents of the flash memory chip onto a diskette, giving you a backup copy of the original motherboard BIOS in case you need to re-install it. Select N to **DO YOU WANT TO SAVE BIOS**, if you don't want to save the old BIOS file.
7. After the decision to save the old BIOS file or not is made, select Y to **ARE YOU SURE TO PROGRAM** when the next menu appear; wait until a message showing Power Off or Reset the system appears. Then turn off your system.
8. Remove the diskette and restart your system.
9. Hold down <Delete> key to enter BIOS setup. You must select "Load Fail-Safe Default" to activate the new BIOS, then you may set other item from the main menu.

Appendix E: EasyTuneIII Utilities Installation

Insert the support CD that came with your motherboard into your CD-ROM driver or double-click the CD driver icon in My Computer to bring up the screen.

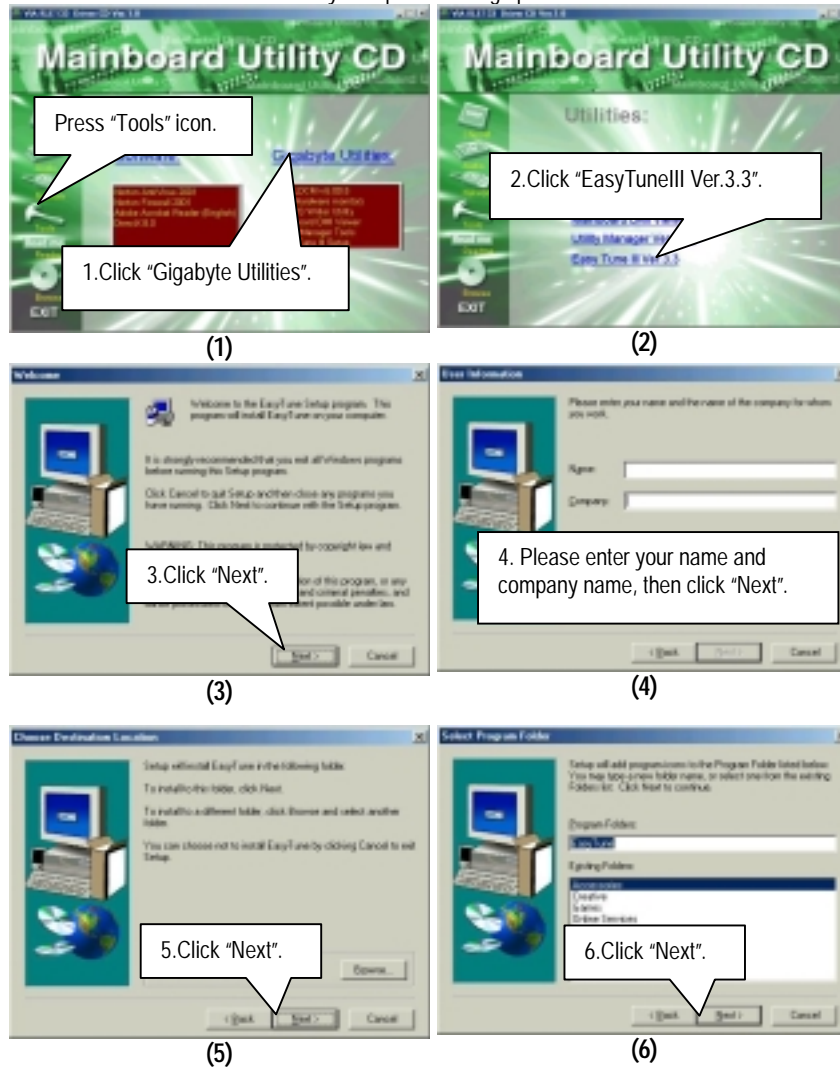

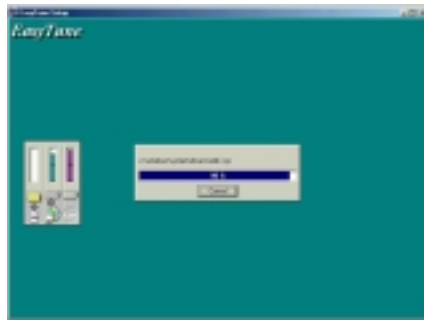

(7)

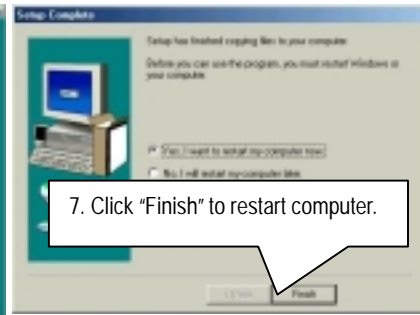

(8)

Appendix F: Acronyms

| Acronyms | Meaning |
|----------|---|
| ACPI | Advanced Configuration and Power Interface |
| APM | Advanced Power Management |
| AGP | Accelerated Graphics Port |
| AMR | Audio Modem Riser |
| ACR | Audio Communication Riser |
| BIOS | Basic Input / Output System |
| CPU | Central Processing Unit |
| CMOS | Complementary Metal Oxide Semiconductor |
| CRIMM | Continuity RIMM |
| CNR | Communication and Networking Riser |
| DMA | Direct Memory Access |
| DMI | Desktop Management Interface |
| DIMM | Dual Inline Memory Module |
| DRM | Dual Retention Mechanism |
| DRAM | Dynamic Random Access Memory |
| DDR | Double Data Rate |
| ECP | Extended Capabilities Port |
| ESCD | Extended System Configuration Data |
| ECC | Error Checking and Correcting |
| EMC | Electromagnetic Compatibility |
| EPP | Enhanced Parallel Port |
| ESD | Electrostatic Discharge |
| FDD | Floppy Disk Device |
| HDD | Hard Disk Device |
| IDE | Integrated Dual Channel Enhanced |
| IRQ | Interrupt Request |
| I/O | Input / Output |
| IOAPIC | Input Output Advanced Programmable Input Controller |
| ISA | Industry Standard Architecture |
| LAN | Local Area Network |
| LBA | Logical Block Addressing |
| LED | Light Emitting Diode |
| MHz | Megahertz |
| MIDI | Musical Interface Digital Interface |
| MTH | Memory Translator Hub |
| MPT | Memory Protocol Translator |
| NIC | Network Interface Card |
| OS | Operating System |

To be continued...

7VMM Motherboard

| Acronyms | Meaning |
|----------|-----------------------------------|
| OEM | Original Equipment Manufacturer |
| PAC | PCI A.G.P. Controller |
| POST | Power-On Self Test |
| PCI | Peripheral Component Interconnect |
| RIMM | Rambus in-line Memory Module |
| SCI | Special Circumstance Instructions |
| SECC | Single Edge Contact Cartridge |
| SRAM | Static Random Access Memory |
| SMP | Symmetric Multi-Processing |
| SMI | System Management Interrupt |
| USB | Universal Serial Bus |
| VID | Voltage ID |